

Ball Spline

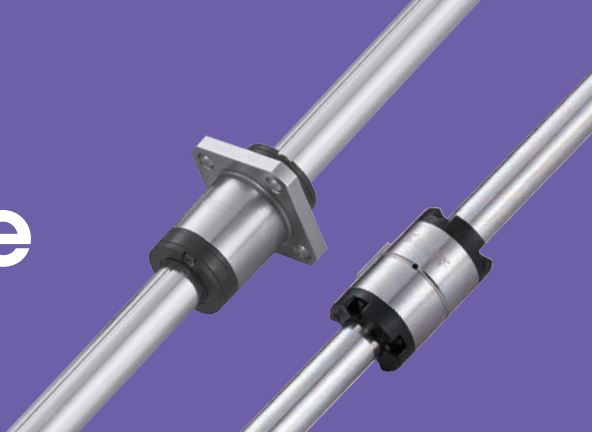

1-1 Structure and Benefits of TBI MOTION Ball Spline.....	B02
1-1-1 Basic Structure of TBI MOTION Ball Spline.....	B02
1-1-2 TBI MOTION Nut Design and Shaft Specifications.....	B02
1-1-3 Features of TBI MOTION Ball Spline	B03
1-1-4 TBI MOTION Ball Spline Type and Feature.....	B04
1-2 The Procedure of Select Ball Spline	B05
2-1 The Strength of Spline Shaft	B06
2-1-1 The Bending Load Applied on the Operating Ball Spline	B06
2-1-2 The Torque Applied on the Operating Ball Spline	B06
2-1-3 Both Bending Moment and Twisting Moment Applied Simultaneously on the spline shaft.....	B07
2-1-4 Rigidity of the Spline Shaft.....	B07
2-1-5 Deflection and Deflection Angle of the Spline Shaft	B08
2-1-6 Critical Speed of Spline Shaft	B10
2-1-7 Spline-Shaft Cross-Section.....	B11
2-2 Service Life Expectancy.....	B12
2-2-1 Nominal Service Life	B12
2-2-2 Calculating Nominal Service Life	B12
2-2-3 Calculating the Average Applied Load	B14
2-2-4 Equivalent Factor	B15
2-3 Calculating the Service Life	B16
2-4 Determining the Preload.....	B20
2-4-1 Clearance in the Rotational Direction.....	B20
2-4-2 Preload and Rigidity.....	B20
2-4-3 Operating Conditions and Determination of the Preload Level	B21
2-5 Accuracy	B22
2-5-1 Accuracy Grade.....	B22
2-5-2 Accuracy Specifications.....	B22
2-6 Lubrication	B24
2-7 Material and Surface Treatment	B24
2-8 Precautions of Ball Spline.....	B25
2-8-1 General Maintenance	B25
2-8-2 Lubrication.....	B25
2-8-3 Storage.....	B25
2-9 Mounting	B26
2-9-1 Tolerance on Support Unit.....	B26
2-9-2 Installation of Ball Spline	B26
2-9-3 Installation of Spline Nut.....	B27
3-1 Nominal Model Code of Ball Spline SL Series.....	B28
3-1-1 Nominal Model Code.....	B28
3-2 Nominal Model Code of Ball Spline SO Series	B36
3-2-1 Nominal Model Code.....	B36

ABOUT BALL SPLINE

1-1 Structure and Benefits of *TBI MOTION* Ball Spline

■ 1-1-1 Basic Structure of *TBI MOTION* Ball Spline

The design of TBI Ball spline is to utilize the friction through the contact of steel balls within in the Spline Nut and the grooves on the Spline Shaft. With TBI MOTION's unique 40° angular contact design which enables the Ball spline delivers high sensitivity and extreme high load carrying capacity. The concept is optimal for the application involve with high speed, vibration, impacts of loading and precise positioning requirements. Also when the Ball spline is used to function as linear bushing, the Ball spline provides ten times loading capacity than the linear bush on the like model but with a compact profile. Namely, Durability and reliability is the reason to choose TBI Ball spline in your application.

■ 1-1-2 *TBI MOTION* Nut Design and Shaft Specifications

TBI MOTION Spline Nut is available in four different designs : SLF (Flange design), SLT (Non-flange design), SOF (Cylindrical flange design), SOT (Round design), Point of contacts on the Spline shaft is provided in two grooves (180°) (SLF/SLT 6~20), (SOT/ SOF 8~25) and four grooves (70°) base on the diameter of the Spline shaft. Also TBI provides Hollow Spline shaft for alternative.

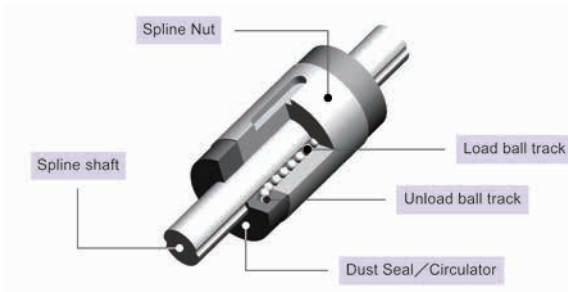

Fig 1.1.1

■ 1-1-3 Features of *TBI MOTION* Ball Spline

High Load-Carrying Capacity

Every groove on the TBI Spline shaft is precision ground to form a perfect 40° angular contact point. The concept of 40° contact design is to increase the load carrying capacity and rigidity to handle a greater moment load.

Zero Angular Clearance / Backlash

Grooves on the TBI Spline shaft is precision ground to form a perfect Gothic arch. The design eliminates clearance that could generate deflections, and therefore best suited for the applications that required high precision.

High Sensitivity

The unique TBI 40° angular contact is designed to operate with the minimum friction while the design performs high sensitivity and rigidity.

High Rigidity

A wide contact angle and an appropriate level of preload are combined to provide high rigidity and stiffness.

Mount-Simple on Design

TBI Ball Spline is low maintenance design, therefore, when removing the spline nut is necessary due to the ball retaining design the steel balls will not fall apart like the traditional nut design.





ABOUT BALL SPLINE

1-1 Structure and Benefits of *TBI MOTION* Ball Spline

■ 1-1-4 *TBI MOTION* Ball Spline Type and Feature

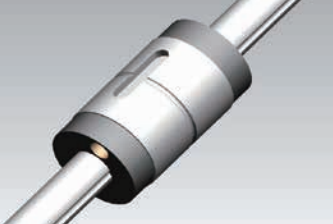
Spline Nut

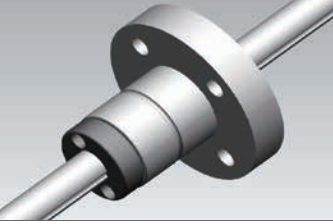
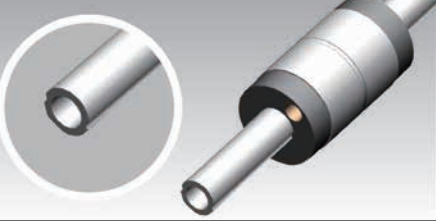
Spline Shaft

SLT, SOT Non-flanged Spline Nut	Standard Precision Spline Shaft (S-Type)
	
<p>SLT, SOT Spline nut is with a straight cylindrical shape without flange. The standard mode of mounting a cylindrical nut is by using a key. The cylindrical nut will have a keyway and separate key. A matching keyway must be bored into the housing or block that will be mounted on the cylinder nut. The type SLT, SOT is the most compact profile Spline nut in TBI Ball Spline product line.</p>	<p>The Standard precision Spline shaft is precisely ground to reach high accuracy and smoothness.</p>
SLF, Flanged Spline Nut	Hollow Spline Shaft (H-Type)
	
<p>Flange nut is simpler to install because it only requires a rough bore and mounting holes drilled and tapped to secure the flange to the housing.</p>	<p>Hollow Spline shaft is optional for the customer to choose for its application. Hollow Spline shaft is designed to reduce weight, accommodate pipes and ventilation.</p>
SOF, Square Flanged Spline Nut	Custom Machining Spline Shaft
	
<p>The nut with square flange is easy to be installed to the housing through mounting holes and will be applied to 3C industry and semiconductor industry.</p>	<p>TBI has the capability to manufacture custom made Spline shaft by machining it to meet the requirements of special Spline Shaft shape. For example, a shaft with a bigger diameter on both ends or on the center of Spline shaft can be manufactured upon request.</p>

B

Ball Spline

1-2 The Procedure of Select Ball Spline

Table 1.2.1

Steps	Description
1.Set the Operational conditions	<ul style="list-style-type: none"> ● Stroke Length : Ls ● Velocity : V ● The Applied Load : W ● Size ● Installation <ul style="list-style-type: none"> ● Operation environment ● Service life expectancy ● Accuracy ● Frequency of use (load cycle) ● Rigidity
2.Select a Type	<ul style="list-style-type: none"> ● Refer to Type, Shaft Spec to determine the your Ballspline.
3.Calculating the strength of Spline shaft	<ul style="list-style-type: none"> ● Spline Shaft Diameter ● Spline-Shaft Length ● End Fixity ● The permissible load of Ballspline ● The displacement under torque and deflection
4.Service expectancy	<div style="text-align: center;"> <pre> graph TD A[Calculating TBI Ball spline service life expectancy by using expectancy formula.] -- IF --> B{NO Required service life.} B -- NO --> C[] B -- IF --> A </pre> </div>
5.Determined the preload	<ul style="list-style-type: none"> ● Determined the permissible axial clearance/ backlash
6.Determine the Accuracy Grade	<ul style="list-style-type: none"> ● Accuracy Grades
7.Operational condition	<ul style="list-style-type: none"> ● Lubrication ● Lubrication methods ● Surface treatment ● Dust prevention methods
	Selected

2-1 The Strength of Spline Shaft

The Spline shaft is designed to absorb radial load and torque during operation. Therefore, the strength of Spline shaft must be taken into consideration when the Ball spline operates under extreme loading or torque.

2-1-1 The Bending Load Applied on the Operating Ball Spline

The maximum of bending moment (M) can be attributed to multi-factor such as the end fixity methods, length of Spline shaft, load capacity, etc. Equation (1) is equipped to help the user to obtain the ideal length of the Spline shaft in order to be the reference of obtaining the ideal strength of Ball spline.

$$M = \sigma \cdot Z \text{ and } Z = \frac{M}{\sigma} \dots(1)$$

M : Bending moment (N-mm)

σ : Shaft permissible bending stress (98 N/mm²)

Z : Shaft section modulus (mm³)

* Refer to Table 2.1.2, 2.1.3

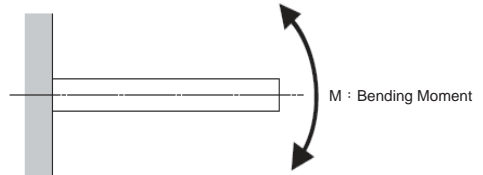

Fig 2.1.1

2-1-2 The Torque Applied on the Operating Ball Spline

The maximum torque applied on the Spline shaft can be calculated through maximum twisting moment (T). Equation (2) is equipped to help the user to obtain the ideal length of the Spline shaft.

$$T = \tau_a \cdot Z_p \text{ and } Z_p = \frac{T}{\tau_a} \dots(2)$$

T : Maximum twisting moment (N · mm)

τ_a : Shaft permissible twisting Stress (49 N/mm²)

Z_p : Shaft polar section modulus (mm³)

* Refer to Table 2.1.2, 2.1.3

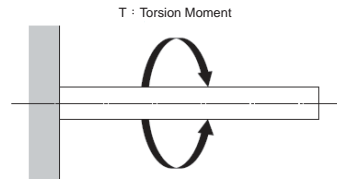

Fig 2.1.2

■ 2-1-3 Both Bending Moment and Twisting Moment Applied Simultaneously on the Spline Shaft

To calculate the figure for both bending (M) and twisting moments (T) applied on the Spline shaft via equation (3) and (4) get the equivalent bending moment (Me) and equivalent twisting moment (Te). Adopt the greater value from equation (3) and (4) to determine the ideal Spline-shaft length.

Equivalent Bending Moment

$$M_e = \frac{M + \sqrt{M^2 + T^2}}{2} = \frac{M}{2} \left\{ 1 + \sqrt{1 + \left(\frac{T}{M}\right)^2} \right\} \dots(3)$$

$$M_e = \sigma \cdot Z$$

Equivalent Twisting Moment

$$T_e = \sqrt{M^2 + T^2} = M \cdot \sqrt{1 + \left(\frac{T}{M}\right)^2} \dots(4)$$

$$T_e = \tau_a \cdot Z_p$$

■ 2-1-4 Rigidity of the Spline Shaft

The rigidity of the Spline Shaft is expressed in torsion angle caused by twisting moment. The twisting angle should be limited to no further than 0.25° per 1000 mm.

$$\theta = 57.3 \cdot \frac{T \times L}{G \times I_p} \dots(5)$$

$$\text{Shaft Rigidity} = \text{Torsion Angle} / \text{Unit Length} = \frac{\theta \cdot \ell}{L} < \frac{1^\circ}{4}$$

θ : Torsion Angle (°)

L : Shaft Length (mm)

G : Shear Elastic Modulus ($7.9 \times 10^4 \text{N/mm}^2$)

ℓ : Unit Length (1000mm)

I_p : Polar Moment of Inertia (mm^4)

※ Table 2.1.2, 2.1.3

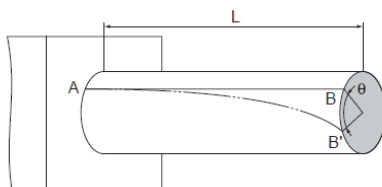

Fig 2.1.3

2-1 The Strength of Spline Shaft

■ 2-1-5 Deflection and Deflection Angle of the Spline Shaft

These should be calculated by using equations that satisfying the relevant operating conditions. Table 2.1.1 presents the operating conditions and the corresponding equations. Tables 2.1.2 & 2.1.3 presents the cross-section factors (Z) and cross-section secondary moments (I). Through the use of the Z, I values given in these tables, the strength and degree of displacement (deflection) of Ball spline model can be obtained.

Table 2.1.1 Deflection and Deflection-Angle Equation

End Fixity	Specification Conditions	Deflection Equation	Deflection-Angle Equation
Both Ends Free		$\delta_{\max} = \frac{Pl^3}{48EI}$	$i_1 = 0$ $i_2 = \frac{Pl^2}{16EI}$
Both Ends Fixed		$\delta_{\max} = \frac{Pl^3}{192EI}$	$i_1 = 0$ $i_2 = 0$
Both Ends Free		$\delta_{\max} = \frac{5Pl^4}{384EI}$	$i_2 = \frac{Pl^3}{24EI}$
Both Ends Fixed		$\delta_{\max} = \frac{Pl^4}{384EI}$	$i_2 = 0$

Table 2.1.1 Deflection and Deflection-Angle Equation

End Fixity	Specification Conditions	Deflection Equation	Deflection-Angle Equation
One Ends Fixed		$\delta_{\max} = \frac{Pl^3}{3EI}$	$i_1 = \frac{Pl^2}{2EI}$ $i_2 = 0$
One Ends Fixed		$\delta_{\max} = \frac{Pl^4}{8EI}$	$i_1 = \frac{Pl^3}{6EI}$ $i_2 = 0$
Both Ends Free		$\delta_{\max} = \frac{\sqrt{3} Mol^2}{216EI}$	$i_1 = \frac{Mol}{12EI}$ $i_2 = \frac{Mol}{24EI}$
Both Ends Fixed		$\delta_{\max} = \frac{Mol^2}{216EI}$	$i_1 = \frac{Mol}{16EI}$ $i_2 = 0$

δ_{\max} : Maximum Deflection (mm)

i_1 : Deflection Angle at a Loading Point (deg)

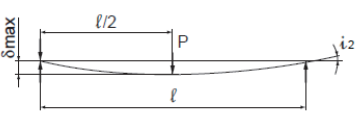
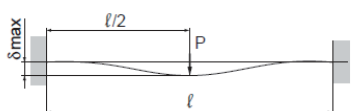
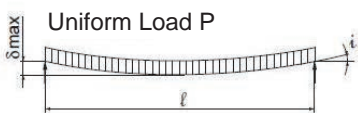
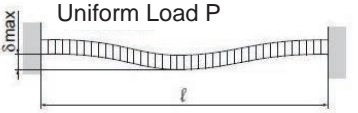
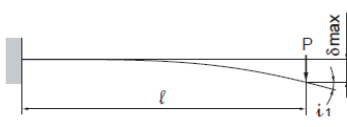
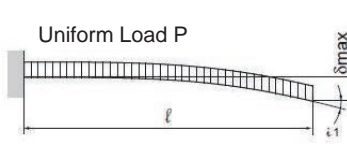
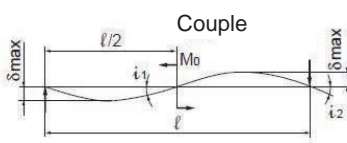
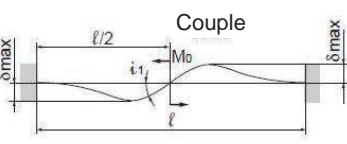
i_2 : Deflection Angle at a Supporting Point (deg)

M_0 : Moment (N-mm)

P : Concentrated Load (N)

p : Uniform Load (N/mm)

l : Span (mm)

I : Geometrical Moment of Inertia (mm⁴)

E : Longitudinal Elastic Modulus

($2.06/10^5$ N/mm²)

2-1 The Strength of Spline Shaft

■ 2-1-6 Critical Speed of Spline Shaft

When an operating Ball spline reaches critical speed, the mechanical resonance occurs, no further operation can be performed. Namely, to keep Ball Spline under ideal operational, the speed limit must be kept under monitor. Therefore, to set an ideal operational speed for safety factor must be settled as 80% of critical speed as shown on equation.

Critical Speed

$$N_c : \frac{60\lambda^2}{2\pi \times \ell_b^2} \times \sqrt{\frac{E \times 10^3 \times I}{\gamma \times A}} \times 0.8$$

N_c : Critical Shaft Speed (min^{-1})

b : Center Distance (mm)

E : Young's Modulus ($2.06 \cdot 10^5 \text{N/mm}^2$)

I : Moment of Inertia of the Shaft (mm^4)

$$I = \frac{\pi}{64} d_1^4$$

d_1 : Diameter (mm)

γ : Density (Specific Gravity) ($7.85 \cdot 10^{-6} \text{kg/mm}^3$)

$$A = \frac{\pi}{4} d_1^2$$

d_1 : Diameter (mm)

A : Spline-Shaft Cross-Sectional Area (mm^2)

λ : Installation-Method-Dependent Factor

(Fig 2.1.4) Fixed-Free $\lambda = 1.875$

(Fig 2.1.5) Supported-Supported $\lambda = 3.142$

(Fig 2.1.6) Fixed-Supported $\lambda = 3.927$

(Fig 2.1.7) Fixed-Fixed $\lambda = 4.73$

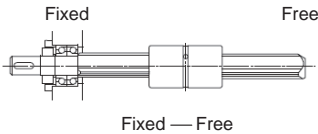

Fig 2.1.4

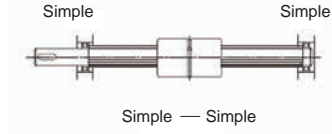

Fig 2.1.5

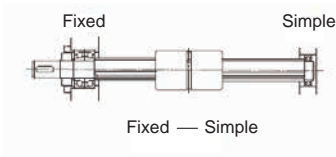

Fig 2.1.6

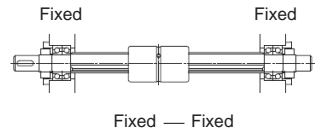

Fig 2.1.7

■ 2-1-7 Spline-Shaft Cross-Section

Table 2.1.2

Nominal Diameter		I (mm ⁴)	Ip (mm ⁴)	Z (mm ³)	Zp (mm ³)
SL 006	Solid	63.49	119.23	18.58	39.74
	Hollow	62.70	117.33	18.32	39.22
SL 008	Solid	200.93	387.53	46.65	96.88
	Hollow	196.96	379.57	45.65	94.89
SL 010	Solid	490.25	933.29	86.61	186.66
	Hollow	477.68	908.16	86.10	181.63
SL 013	Solid	1400.81	2691.54	198.57	414.08
	Hollow	1282.96	2455.82	180.44	377.82
SL 016	Solid	3215.60	6242.70	378.39	780.34
	Hollow	3014.53	5840.57	353.25	730.07
SL 020	Solid	7851.80	15336.59	748.48	1533.66
	Hollow	7360.93	14354.84	699.39	1435.48
SL 025	Solid	18466.30	36932.60	1477.30	2954.61
	Hollow	15981.25	31962.50	1278.50	2557.00
SL 030	Solid	33122.31	77392.48	2579.75	4416.31
	Hollow	29905.32	70958.50	2365.28	3987.38
SL 032	Solid	50322.85	100645.70	3145.18	6290.36
	Hollow	36586.19	73172.38	2286.64	4573.27
SL 040	Solid	120667.43	241334.90	6033.37	12066.74
	Hollow	112813.45	225626.90	5640.67	11281.35
SL 050	Solid	297123.73	594247.50	11884.95	23769.90
	Hollow	274691.98	549384.00	10987.68	21975.36

I : Geometrical moment of inertia (mm⁴)

Ip : Polar moment of inertia (mm⁴)

Z : Section modulus (mm³)

Zp : Polar section modulus (mm³)

Table 2.1.3

Nominal Diameter		I (mm ⁴)	Ip (mm ⁴)	Z (mm ³)	Zp (mm ³)
SO 008	Solid	200.95	389.81	47.22	97.45
	Hollow	196.97	381.86	46.22	95.46
SO 010	Solid	490.68	956.77	93.22	191.35
	Hollow	478.11	931.64	90.71	186.33
SO 012	Solid	1017.67	1998.75	163.51	333.13
	Hollow	954.05	1871.52	152.91	311.92
SO 015	Solid	1678.22	3241.10	212.50	476.63
SO 020	Solid	5382.92	10422.07	553.75	1145.28
SO 025	Solid	12796.48	24659.94	1048.86	2182.30

I : Geometrical moment of inertia (mm⁴)

Ip : Polar moment of inertia (mm⁴)

Z : Section modulus (mm³)

Zp : Polar section modulus (mm³)

2-2 Service Life Expectancy

2-2-1 Nominal Service Life

TBI define the nominal service life of Ball Spline as 90% of the average running distance before flaking within in the Ball Spline on the same manufacture cycle. Please note that the nominal life expectancy is only for reference use.

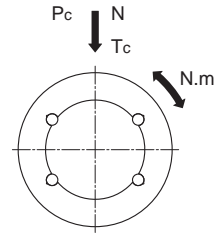

Fig 2.2.1

2-2-2 Calculating Nominal Service Life

The factors which influence the service life for Ball Splines can be attributed to three main aspects, the torque, radial load and moment. The influence of each aspect can be calculated through equations (7) to (10).

Under a Torque

$$L = \left(\frac{f_T \cdot f_C}{f_w} \cdot \frac{C_T}{T_c} \right)^3 \cdot 50 \dots(7)$$

Under a Radial Load

$$L = \left(\frac{f_T \cdot f_C}{f_w} \cdot \frac{C}{P_c} \right)^3 \cdot 50 \dots(8)$$

L : Nominal Service Life (km)

C_T : Basic Dynamic-Torque (N-m)

T_c : Calculated Torque Applied (N-m)

C : Basic Dynamic-Load Rating (N)

P_c : Radial Load (N)

f_T : Temperature (See Fig 2.2.2)

f_C : Contact (See Table 2.2.1)

f_w : Load Factor (See Table 2.2.2)

Under both a moment and radial load applied simultaneously

Calculate the service life from the sum of the radial load and the equivalent radial load.

Under both a torque and radial load applied simultaneously

In this case, calculate the equivalent radial

load to determine service life by equation (9).

$$P_E = P_c + \frac{4 \cdot T_c \cdot 10^3}{i \cdot BCD \cdot \cos \alpha} \dots(9)$$

P_E : Equivalent radial Load (N)

$\cos \alpha$: Contact Angle

i : Number of Loaded Rows of Balls

BCD : Ball Center to Center Shaft Diameter (mm)

(See Table 3.1.1)

Under a moment on a spline nut or two closely attached to one another

Obtain the equivalent radial load using the equation,

and determine the service life by equation (10).

$$P_u = K \cdot M \dots(10)$$

P_u : Equivalent Radial Load (N)(Moment Applied)

K : Equivalent Factor (See Table 2.2.3)

M : Applied Moment (N-mm)

However, M should be within the range of the static permissible moment.

Calculating Nominal Service Life

Once the nominal life (L) is obtained, if the stroke length and the number of reciprocal operations are consistent, the service life in hours can be obtained by using the following equation.

$$L_h = \frac{L \cdot 10^3}{2 \cdot \ell_s \cdot n_1 \cdot 60}$$

L_h : Service Life in Hours (h)
 ℓ_s : Stroke Length (m)
 n_1 : Number of Reciprocal Operations per Minute (min^{-1})

Temperature Factor (f_T)

When the Ball Spline operates in an environment which the temperature reaches 100°C or higher, considering that the heat may adversely affect the operation of the Ball Spline. To avoid malfunction under extreme temperature, Fig 2.2.2 should be taken into consideration. In addition that the material of Ball Spline should be heat resistant and custom made when use under extreme environment.

※Please inform TBI sales for upgrading the material for the operation environment exceeds 80°C for the reason that the materials of seal and retainers should be upgraded to sustain the high-temperature.

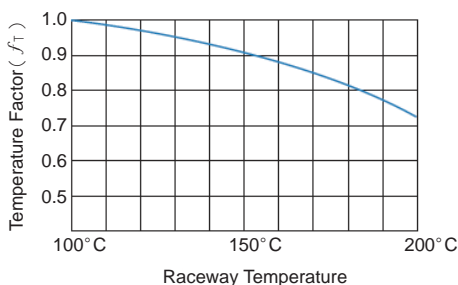

Fig 2.2.2 Temperature Factor (f_T)

Contact Factor (f_c)

When one or multiple Spline nuts are mounted on the Spline shaft closeley , their linear motion is affected by moments and mounting accuracy, resulting in nonuniform load distribution. When closely linked spline nuts are used, multiply the basic load rating (C or C_o) by one of the contact factors specifiedbelow.

※If a nonuniform load distribution is expected, as in large equipment, take the contact factor explained in Table 4 into account.

Table 2.2.1 Contact Factor (f_c)

No. of Spline nuts Linked	f_c
2	0.81
3	0.72
4	0.66
5	0.61
In Normal Use	1.0

Load Factor (f_w)

The operation of reciprocal machines is likely to cause vibration and impact. It is difficult to determine the rating of vibration, impact in the event of vibration, and repeated impact during high speed operation, and triggering and ceasing of operation. Therefore, when loads exerted on a linear-motion or operation velocity and vibration is extreme. Take the basic load rating (C or C_o) and multiply the figure shown in table 2.2.2

Table 2.2.2 Load Factor (f_w)

Vibration Impact	Velocity (V)	f_w
Minor	Minor velocity $V \leq 0.25$ m/s	1-1.2
Little	Low velocity $0.25 < V \leq 1.0$ m/s	1.2-1.5
Medium	Medium Velocity $1.0 < V \leq 2.0$ m/s	1.5-2.0
Heavy	High velocity $V > 2.0$ m/s	2.0-3.5

2-2 Service Life Expectancy

■ 2-2-3 Calculating the Average Applied Load

The applied load fluctuates during the operation, for instance the applied load is different during the activities of an industrial robotic arm, industrial robot arm initiates with a workpiece and returns without one, the Ball Spline nut receives variable loads. The fluctuation of applied load influence the service life of Ball Spline, therefore the calculation of service life must take such fluctuation into consideration. When the service life of a Ball Spline with variable load is equal to the one with certain load then that certain load is called the Mean Load.

The Equation is as below

$$P_m = \sqrt[3]{\frac{1}{L} \cdot \sum_{n=1}^n (P_n^3 \cdot L_n)}$$

P_m : Mean Load (N)
 P_n : Fluctuating Load (N)
 L : Total Stroke
 L_n : Stroke under Load P_n (mm)

For Loads That Change Stepwise

$$P_m = \sqrt[3]{\frac{1}{L} (P_1^3 \cdot L_1 + P_2^3 \cdot L_2 \dots P_n^3 \cdot L_n)}$$

P_m : Mean Load (N)
 P_n : Fluctuating Load (N)
 L : Total Running Distance (mm)
 L_n : Running Distance Under Load P_n (mm)

For Loads That Change Monotonically

$$P_m = \sqrt[3]{\frac{1}{L} (P_{min}^3 \cdot L + P_{max}^3 \cdot L)}$$

P_{min} : Minimum Load (N)
 P_{max} : Maximum Load (N)

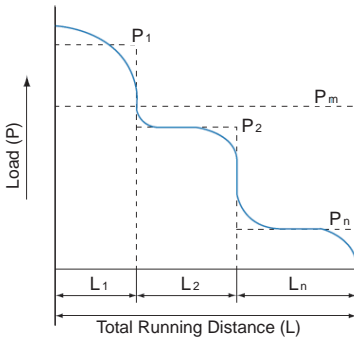

Fig 2.2.3

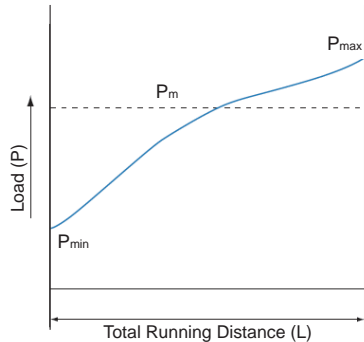

Fig 2.2.4

For Loads That Change Sinusoidal

(a) $P_m \cong 0.65 P_{max}$

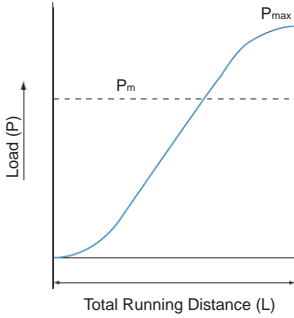

Fig 2.2.5

(b) $P_m \cong 0.75 P_{max}$

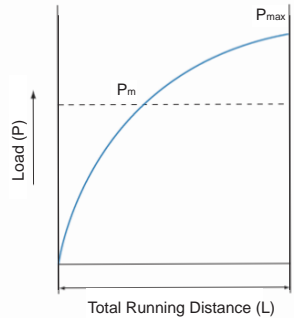

Fig 2.2.6

■ 2-2-4 Equivalent Factor

Table 2.2.3 Equivalent Factor

Model No.	Equivalent Factor : K	
	One Spline Nut	Two Spline Nuts
SL 06	0.577	0.065
SL 08	0.577	0.059
SL 10	0.418	0.047
SL 13	0.360	0.043
SL 16	0.229	0.033
SL 20	0.201	0.029
SL 25	0.154	0.023
SL 30	0.126	0.021
SL 32	0.114	0.019
SL 40	0.110	0.016
SL 50	0.109	0.013

Model No.	Equivalent Factor : K	
	One Spline Nut	Two Spline Nuts
SO 08	0.400	0.061
SO 10	0.308	0.052
SO 12	0.253	0.046
SO 15	0.219	0.040
SO 20	0.186	0.031
SO 25	0.154	0.026

2-3 Calculating the Service Life

Horizontal Application

A 300 mm long Ball Spline supported by two fixed nuts in a horizontal application, the load of the Spline falls vertically downward on the fixed side with 30 mm away from the center of ball spline with the gravity force of $W = 30$ kg. The figure is shown as Fig 2.3.1

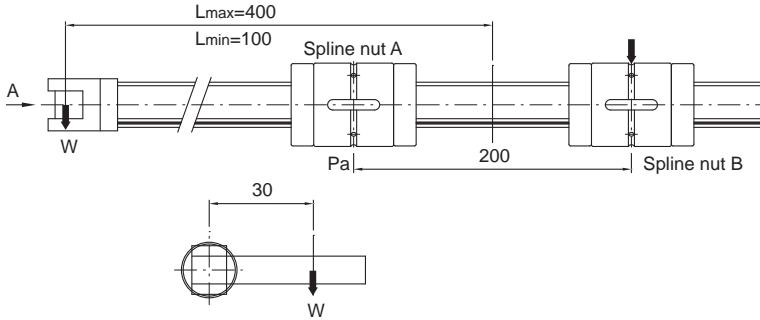

Fig 2.3.1

A. Calculates the Spline Shaft Strength

The presented structure of ball spline is an extended bridge, it is designed to absorb torque, therefore, the maximum bending load occurs on Spline nut A :

$$\text{Maximum Bending Moment } M = 30 \cdot 9.81 \cdot 400 = 117720 \text{ N}\cdot\text{mm}$$

$$\text{Maximum Torsion Moment } T = 30 \cdot 9.81 \cdot 30 = 8829 \text{ N}\cdot\text{mm}$$

For Ball Spline shafts subjected to the simultaneous application of torsion and bending loads, thus the calculation should include Equivalent Bending Moment, M_e and Equivalent Torsion Moment T_e :

$$M_e = \frac{M + \sqrt{M^2 + T^2}}{2} = 117885 \text{ N}\cdot\text{mm} \quad T_e = \sqrt{\frac{M^2 + T^2}{2}} = 118051 \text{ N}\cdot\text{mm}$$

$$T_e > M_e$$

$$\therefore T_e = \tau_a \cdot Z_p$$

$$\therefore Z_p = T_e / \tau_a = 118051 / 49 = 2409.2 \text{ mm}^3$$

According to figure of cross section showed on the spline (Table 2.1.3, 2.1.4), the minimum diameter, 25mm is required in order to gain enough strength of Ball Spline, therefore, SLF25 matches the requirement above thus choose SLF25.

B. Calculating the Mean Load

When the shaft extension reached $L_{max} = 400$ mm, it reaches it' maxima load (P_{max})

When it retrieved back to $L_{min} = 100$ mm, it absorbed the minimum of load (P_{min})

According to mechanics it allows us to acquire the maximum and minimum Radial Load of Nut A and nut B :

$$P_{Amax} = 30 \cdot 9.81 \cdot (400+200)/200 = 882.9 \text{ N}$$

$$P_{Bmax} = 30 \cdot 9.81 \cdot 400/200 = 588.6 \text{ N}$$

$$P_{Amin} = 30 \cdot 9.81 \cdot (100+200)/200 = 441.5 \text{ N}$$

$$P_{Bmin} = 30 \cdot 9.81 \cdot 100/200 = 147.2 \text{ N}$$

When the movement of Ball Spline occurs, the load on the spline is gradual and repeated, according to Fig 2.2.4 the equation of the load on ball spline is shown as :

$$P_{Am} = 1/3 (P_{Amin} + 2P_{Amax}) = 735.8 \text{ N}$$

$$P_{Bm} = 1/3 (P_{Bmin} + 2P_{Bmax}) = 441.5 \text{ N}$$

The nuts receive both torsion and bending load simultaneously, therefore assuming that the torsion distributes equally on the nuts. The equation for torsion is shown as T' :

$$T' = T/2 = 30 \cdot 9.81 \cdot 30/2 = 4414.5 \text{ N}\cdot\text{mm}$$

The equivalent factor P_e (B12, equation (9)) :

$$P_e = P_m + \frac{4 \cdot T'}{i \cdot dp \cdot \cos \alpha}$$

$$P_{AE} = 735.8 + \frac{4 \cdot 4414.5}{4 \cdot 27 \cdot \cos 50^\circ} = 990.2 \text{ N}$$

$$P_{BE} = 441.5 + \frac{4 \cdot 4414.5}{4 \cdot 27 \cdot \cos 50^\circ} = 695.9 \text{ N}$$

C. Service Life Ball Spline

$$\text{Nut A life } L_A = \left(\frac{f_T \cdot f_C}{f_w} \cdot \frac{C}{P_{AE}} \right)^3 \cdot 50 = 14518 \text{ km}$$

$$\text{Nut B life } L_B = \left(\frac{f_T \cdot f_C}{f_w} \cdot \frac{C}{P_{BE}} \right)^3 \cdot 50 = 41829 \text{ km}$$

Factors
 f_T : Temperature = 1
 f_C : Friction = 1
 f_w : Load = 1.5
 C : Coa = 9835 N

The service life of Ball Spline correlates with nut A and the service life is 14518 by estimate.

Vertical Application

A 1200 mm long ball spline with stroke of 1000 mm is mounted on a working platform supported by two fixed nuts on both end. The geometry is shown as Fig 2.3.2

The point of drive force F is $X_1 = 50$ mm, from the center of Ball Spline, the weight platform W_1 is 27 kg, the center of the weight is $X_2 = 300$ mm, away from the center of ball spline, the working cycle of platform is a carriage of $W_2 = 5$ kg, with a downward movement for 5 sec and holds for 10 sec, then elevates for 5 sec and holds for 10 sec to unload the carriage repeatedly. The center of gravity of carriage is $X_3 = 500$ mm, from the center of ball spline, the travelling of velocity is shown as Fig 2.3.2

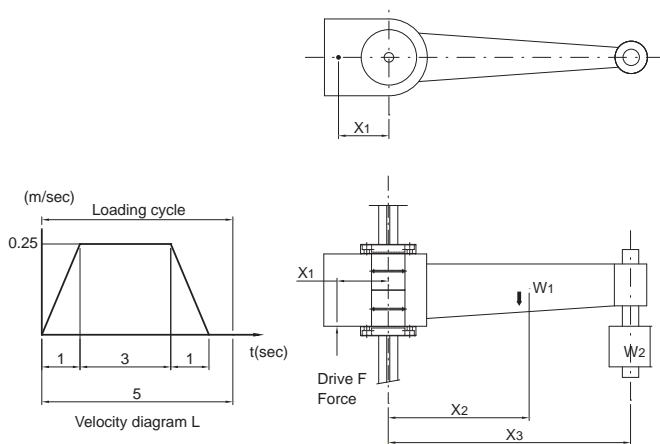

Fig 2.3.2

2-3 Calculating the Service Life

A. Analysis on Different Stage of Exertion

Inertial force occurs when a platform is in working modes, drive force is the source of the inertial force.

Inertial force of a m/s^2 in accelerated ascent and decelerated decent : $F = W \cdot (9.81+a)$

Inertial force of Constant velocity in acceleration and deceleration : $F = W \cdot (9.81)$

Inertial force of a m/s^2 in accelerated decent and decelerated ascent : $F = W \cdot (9.81-a)$

Below are the equations of the bending force absorb by the nuts during acceleration, constant velocity, deceleration while ball ascent and decent.

(1) Without carriage (Acceleration while decent)

$$M_{da} = W_1 \cdot (9.81-a) \cdot 300 + W_1 \cdot (9.81-a) \cdot 50 = 90342 \text{ N-mm}$$

(2) Without carriage (Constant velocity while decent)

$$M_{dc} = W_1 \cdot (9.81) \cdot 300 + W_1 \cdot (9.81) \cdot 50 = 92704.5 \text{ N-mm}$$

(3) Without carriage (Deceleration while decent)

$$M_{dd} = W_1 \cdot (9.81+a) \cdot 300 + W_1 \cdot (9.81+a) \cdot 50 = 95067 \text{ N-mm}$$

(4) With carriage (Acceleration while ascent)

$$M_{aa} = W_1 \cdot (9.81+a) \cdot 300 + W_1 \cdot (9.81+a) \cdot 50 + W_2 \cdot (9.81+a) \cdot 500 + W_2 \cdot (9.81+a) \cdot 50 = 122732 \text{ N-mm}$$

(5) With carriage (Constant velocity while ascent)

$$M_{ac} = W_1 \cdot (9.81) \cdot 300 + W_1 \cdot (9.81) \cdot 50 + W_2 \cdot (9.81) \cdot 500 + W_2 \cdot (9.81) \cdot 50 = 119682 \text{ N-mm}$$

(6) With carriage (Deceleration while ascent)

$$M_{ad} = W_1 \cdot (9.81-a) \cdot 300 + W_1 \cdot (9.81-a) \cdot 50 + W_2 \cdot (9.81-a) \cdot 500 + W_2 \cdot (9.81-a) \cdot 50 = 116632 \text{ N-mm}$$

B. The Calculation of Spline Strength

The presented structure of ball spline is supported by two fixed nuts on both ends with an bridge of absorbing bending in the middle. it designed to absorb torque. According to mechanics the Maximum bending load occurs on the supporting end. The Maximum Bending Moment should occur at the end of acceleration.

Maximum Bending Moment $M = 122732 \text{ N-mm}$

$$\therefore Z = M/\sigma_a = 122732/98 = 1252.4 \text{ mm}^3$$

According to figure of cross section showed on the spline, the minimum diameter 25 mm is required in order to gain enough of strength for Ball Spline, therefore SLF25 matches the requirement above thus choose SLF25.

C. Calculating the Mean Load

The nuts and spline mainly affect by the force of bending, therefore converting the force of bending into rail load by using (B12, equation(10)).

$$P_n = K \cdot M$$

According to Table 2.2.3, when joint two SLF25 nuts, The equivalent factor $K = 0.023$

$$P_{da} = 0.023 \cdot 90342 = 2078 \text{ N}$$

$$P_{aa} = 0.023 \cdot 122732 = 2822.8 \text{ N}$$

$$P_{dc} = 0.023 \cdot 92704.5 = 2132.2 \text{ N}$$

$$P_{ac} = 0.023 \cdot 119682 = 2752.7 \text{ N}$$

$$P_{dd} = 0.023 \cdot 95067 = 2186.5 \text{ N}$$

$$P_{ad} = 0.023 \cdot 116632 = 2682.5 \text{ N}$$

The average load in every time period can be calculate as P_m :

$$P_m = \sqrt[3]{\frac{1}{L} \cdot \sum_{n=1}^n (P_n^3 \cdot L_n)}$$

P_m : Average Load (N)
 P_n : Load in variable (N)
 L : Total service distances (mm)
 L_n : P_n Service distances (mm) under loading

$$P_m = \sqrt[3]{\frac{1}{1000} \{125 \cdot 2078^3 + 750 \cdot (2132.2)^3 + 125 \cdot (2822.8)^3 + 750 \cdot (2752.7)^3 + 125 \cdot (2682.5)^3\}}$$

$$= 2481.6 \text{ N}$$

D. Analysis of Ball Spline Service Life

$$\text{Service Life } L_A = \left(\frac{f_T \cdot f_C}{f_W} \cdot \frac{C}{P_m} \right)^3 \cdot 50 = 922 \text{ km}$$

$$f_T : \text{Temperature} = 1$$

$$f_C : \text{Friction} = 1$$

$$f_W : \text{Load} = 1.5$$

$$C : \text{Coa} = 9835 \text{ N}$$

2-4 Determining the Preload

The preload, a significant factor that influence the accuracy, load capacity and rigidity of Ball Spline during operation. Therefore, it is very important to determine the most appropriate size of the clearance for your requirements. The size of the clearance is standardized for each type, enabling the one best-suited for operating conditions to be selected.

■ 2-4-1 Clearance in the Rotational Direction

With the Ball Spline, the sum of clearances in the circumferential direction is standardized as the clearance in the rotational direction. Clearance in the Rotational Direction. (BCD)

■ 2-4-2 Preload and Rigidity

The preload is the load applied to balls prior to use for the purposes of eliminating angular backlash (clearance in the rotational direction) and improving rigidity. The application of a preload can eliminate angular backlash in the Ball Spline in accordance with the level of applied preload, and can improve rigidity. Fig 2.4.2 shows the amount of displacement in the rotational direction when a rotational torque is applied. As shown in Fig 2.4.2, the effect of pre-loading continues until the torque becomes

Fig 2.4.2 2.8 times greater than the preload applied. Compared with a setting without a preload, the displacement at the same rotational torque is half of the one with a preload and the rigidity is twice as great.

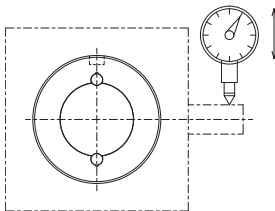

Fig 2.4.1

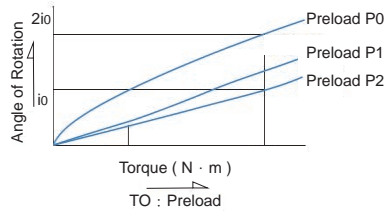

Fig 2.4.2

■ 2-4-3 Operating Conditions and Determination of the Preload Level

Table 2.4.1 presents guidelines for determining the appropriate clearance in the rotational direction for different operating environment. The rotational clearance of the Ball Spline significantly affects the accuracy and rigidity of the Spline nut. Therefore, it is critical to select the clearance best suited to the intended uses of the Ball Spline. Normally, the Ball Spline is preloaded. When it is subjected to repeated swiveling and reciprocal linear motion, the system receives heavy vibration and impact. In such an environment, preload prolongs the service life and improves accuracy.

Table 2.4.1 Guidelines for Determining an Appropriate Ball Spline Clearance according the Rotational Direction.

Clearance in the Rotational Direction	Preload	Operating conditions	Applications
	Medium Preload P2	<ul style="list-style-type: none"> High rigidity is required. Vibration and impact are severe. The moment load must be borne by a single spline nut. 	<ul style="list-style-type: none"> Construction-work-vehicle steering shaft. Spot-welding-machine shaft. Automatic-lathe-tool rest indexing shaft.
	Light Preload P1	<ul style="list-style-type: none"> Hanging loads and moments are applied. High position accuracy is required. Alternate loads are applied. 	<ul style="list-style-type: none"> Industrial robot arm Various automatic loaders. Automatic-painting-machine guideshaft. Electric-discharge-machine spindle. Press die-set guideshaft. Drilling-machine spindle.
	No Preload P0	<ul style="list-style-type: none"> Smooth movement should be achieved with only a low magnitude of force. Torque is continually applied in a given direction. 	<ul style="list-style-type: none"> Various measuring instruments. Automatic drafting machine. Shape-measuring instrument. Dynamometer. Wirewinder. Automatic arccutter. Honing-machine spindle. Automatic packing machine.

Table 2.4.2

Preload Nominal Diameter					No Preload P0	Slight Preload P1	Medium Preload P2
6	8	10	12	13	-2 ~ +1	-6 ~ -2	-
15		16	20		-2 ~ +1	-6 ~ -2	-9 ~ -5
25			30		-3 ~ +2	-10 ~ -4	-14 ~ -8
40		50			-4 ~ +2	-16 ~ -8	-22 ~ -14

TECHNICAL INFORMATION

2-5 Accuracy

2-5-1 Accuracy Grade

The accuracy of the Ball Spline is determined by the spline-nut and thus divided into three accuracy grades of Normal(N), High(H), and Precision(P).

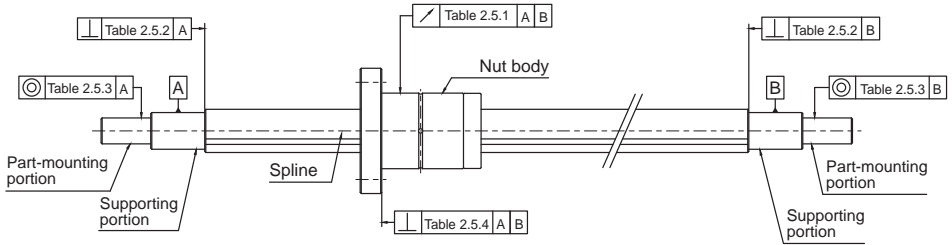

2-5-2 Accuracy Specifications

Tables 2.5.2~2.5.5 indicate the tolerance of callout of the Ball Spline.

Table 2.5.1 The tolerance of Spline Nut on the Support Unit

Unit : μm

Nominal Diameter (mm)		6, 8			10			12, 13, 15, 16, 20			25, 30			40, 50		
		N	H	P	N	H	P	N	H	P	N	H	P	N	H	P
Above	Below															
-	200	72	46	26	59	36	20	56	34	18	53	32	18	53	32	16
200	315	133	89	57	83	54	32	71	45	25	58	39	21	58	36	19
315	400	185	126	82	103	68	41	83	53	31	70	44	25	63	39	21
400	500	236	163	108	123	82	51	95	62	38	78	50	29	68	43	24
500	630	-	-	-	151	102	65	112	75	46	88	57	34	74	47	27
630	800	-	-	-	190	130	85	137	92	58	103	68	42	84	54	32
800	1000	-	-	-	-	-	-	170	115	75	124	83	52	97	63	38
1000	1250	-	-	-	-	-	-	-	-	-	151	102	65	114	76	47

Table 2.5.2 The Maximum Perpendicularity of Spline Shaft End on the Journal Ends

Unit : μm

Accuracy					Normal (N)	High (H)	Precision (P)
6	8	10			22	9	6
12	13	15	16	20	27	11	8
25		30			33	13	9
40		50			39	16	11

Table 2.5.3 The Maximum Radial Call Out on the Attach Surface

Unit : μm

Accuracy					Normal (N)	High (H)	Precision (P)
6	8				33	14	8
10					41	17	10
12	13	15	16	20	46	19	12
25		30			53	22	13
40		50			62	25	15

Table 2.5.4 The Perpendicularity of Flange on the Attach Surface

Unit : μm

Accuracy					Normal (N)	High (H)	Precision (P)
6	8				17	11	8
10	12	13			33	13	9
15	16	20	25	30	30	16	11
40		50			46	19	13

Table 2.5.5 The Accuracy Level on the Effective Length Accuracy

Unit : μm

Accuracy	Normal (N)	High (H)	Precision (P)
Permissible	33	13	6

※ Applies to any effective stroke of 100mm Ball Spline shaft.

2-6 Lubrication

The spline nut is prelubricated prior to shipment for immediate use and the maintenance period is varied according to the operating conditions. TBI suggested that under normal operation condition please lubricate your TBI Ball Spline after 100 Km (6-12 months) of operation. Apply lubricant within the nut body or on the groove of Spline shaft.

2-7 Material and Surface Treatment

Provides customize material and surface treatment in order to meet extreme operation condition. Please contact service window for customized surface treatment and material.

2-8 Precautions of Ball Spline

■ 2-8-1 General Maintenance

- (1) Disassemble ball spline without supervise of certified engineer will cause malfunction of the ball spline.
- (2) Gravity causes the spline nut slides when lining the ball spline, handle with care.
- (3) Do not hammer, free fall the ball spline, such action will damaging the ball spline and might hinder the performance of ball spline.
- (4) Prevent debris, scraps from intervene the ball spline cause it will decrease the performance to ball spline or lead to malfunction.
- (5) Prevent the ball spline operates under extreme condition. Contact service window when the TBI ball spline is intend to use under extreme condition.
- (6) Coolant might cause malfunction on the ball spline, please consult certified engineer for the use of coolant.
- (7) Clean attached debris and scraps before relubrication.
- (8) Please consult certified engineer when the ball spline is designed to operate under frequent vibration, vacuum, extreme high and low temperature condition.
- (9) Please consult certified engineer when mounting a through hole on the flanged ball spline.

■ 2-8-2 Lubrication

- (1) Remove anti-dust oil before seal the ball spline with grease.
- (2) Prevent mixing of different kind of grease, it will cause unexpected chemical deform.
- (3) Please contact certified engineer for consulting the use of grease when the ball spline is designed to operate under frequent vibration, vacuum, extreme high and low temperature condition.
- (4) Please consult certified engineer for the use of non-certified grease.
- (5) When using motor oil to serve the purpose of lubrication, it might cause performance declining due to the improper installation, please consult certified engineer.

■ 2-8-3 Storage

Prevent extreme temperature and humidity while storing the ball spline, please use certified seal and storage in a horizontal position.

2-9 Mounting

■ 2-9-1 Tolerance on Support Unit

Ball spline nut and its support unit is bore to minimize the clearance. If high accuracy is not required, then a clearance fit can be used.

Table 2.9.1

Condition	Tolerance within Support Unit
General Operation Condition	H7
Operation Under Minimize of Axial Clearance	J6

■ 2-9-2 Installation of Ball Spline

The installation of the Ball Spline is shown as Fig 2.9.2. Though the strength of mounting is not strictly required, but it has to be certain that the spline shaft firmly fixed on the support unit.

Table 2.9.2 Sample of Spline-Nut Assembly

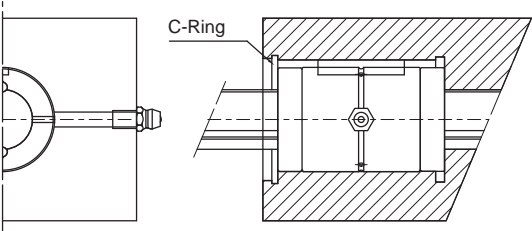
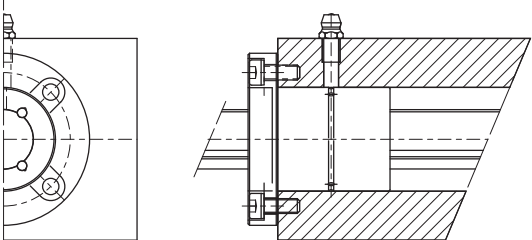
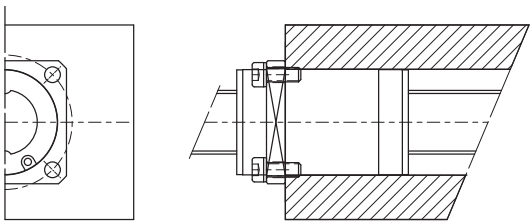
<p>SLT,SOT (C-Ring Type)</p>	
<p>SLF (Flange One- Stage Type)</p>	
<p>SOF (Flange One- Stage Type)</p>	

2-9 Mounting

■ 2-9-3 Installation of Spline Nut

When installing a spline nut into the spline shaft, use a jig shown in fig 2.9.1 to insert the spline with care.

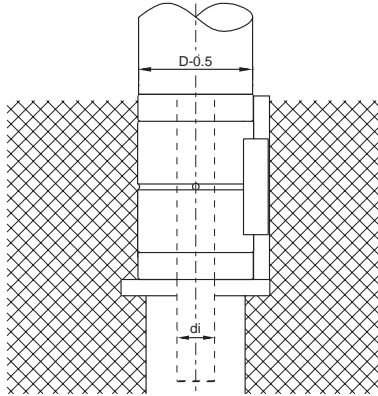

Fig 2.9.1

Table 2.9.3 Specifications of the jig

Unit : mm

Model	Nominal Diameter	6	8	10	13	16	20	25	30	40	50
SL	di	5.0	7.0	8.5	11.5	14.5	18.5	23	28	37.5	46.5
Model	Nominal Diameter	-	8	10	12	15	20	25	-	-	-
SO	di	-	7.0	8.5	10.5	11	16	20.5	-	-	-

TBI MOTION BALL SPLINE

3-1 Nominal Model Code of Ball Spline SL Series

■ 3-1-1 Nominal Model Code

TBI MOTION Ball Spline is classified into interchangeable and non-interchangeable types. Their dimensions are the same; the only difference between two types is that for non-interchangeable series, **TBI MOTION** will finish every process in the production line to meet customers' demands. Interchangeable nuts and shafts can be freely exchanged and the standard preload is P0. Customers could adjust the preload by changing the steel balls inside of the nut by themselves. It is very convenient for customers to have **TBI MOTION** Ball Spline in inventory and make the preload and end machining by themselves. **TBI MOTION** is proud of internal quality control process which is under strict international regulation.

Non-interchangeable Type Code :

SLF 006 T2 N N S - 500 - P0 - B2 + N3 N3

① ② ③ ④ ⑤ ⑥ ⑦ ⑧ ⑨ ⑩ ⑪

①	②	③	④
Spline Nut	Nominal Diameter	Groove	Flange Type
SLF : Flanged SLT : Cylindrical	Unit : mm	T2 : 2 Rows T4 : 4 Rows	N : Round (No Symbol When It is Without the Flange)

⑤	⑥	⑦
Accuracy Grade of Spline Shaft	Spline Shaft Type	Overall Length of Spline Shaft
N : Normal H : High P : Precision	S : Solid H : Hollow	Unit : mm

⑧	⑨	⑩
Preload Value	Number of Spline Nut	Nut Surface Treatment
P0 : No preload P1 : Light preload P2 : Medium preload	(Leave blank if only one nut is required) Ex : Install two spline nuts on a shaft.B2	S : Standard B1 : Black Oxidation N1 : Hard Chrome Plating P : Phosphating N3 : Nickel Plating N4 : Raydent N5 : Chrome Plating

⑪
Shaft Surface Treatment
S : Standard
B1 : Black Oxidation
N1 : Hard Chrome Plating
P : Phosphating
N3 : Nickel Plating
N4 : Raydent
N5 : Chrome Plating

※No symbol required when plating is not needed.

Nominal Model Code for Interchangeable SL Type

Interchangeable Type of Spline Nut :

SLF 006 T2 N + N3

① ② ③ ④ ⑤

① Spline Nut	② Nominal Diameter	③ Groove	④ Flange Type
SLF : Flanged	Unit : mm	T2 : 2 Rows	N : Round (No Symbol When It is Without the Flange)
SLT : Cylindrical		T4 : 4 Rows	

⑤

Nut Surface Treatment
S : Standard
B1 : Black Oxidation
N1 : Hard Chrome Plating
P : Phosphating
N3 : Nickel Plating
N4 : Raydent
N5 : Chrome Plating

Interchangeable Type of Spline Shaft :

SC 006 T2 N S - 500 + N3

① ② ③ ④ ⑤ ⑥ ⑦

① Nominal Model Code	② Nominal Diameter	③ Groove	④ Accuracy Grade of Spline Shaft
	Unit : mm	T2 : 2 Rows	N : Normal
		T4 : 4 Rows	

⑤

Spline Shaft Type
S : Solid
H : Hollow

⑥

Overall Length of Spline Shaft
Unit : mm

⑦

Nut Surface Treatment
S : Standard
B1 : Black Oxidation
N1 : Hard Chrome Plating
P : Phosphating
N3 : Nickel Plating
N4 : Raydent
N5 : Chrome Plating

TBI MOTION BALL SPLINE

3-1 Nominal Model Code of Ball Spline SL Series

SLF, SLT Spline Shaft Cross-Sectional Shape

Table 3.1.1, 3.1.2 indicates the cross-section of spline shaft. When the shaft end is round pillar type the minor diameter must not be greater than the diameter of groove ridge.

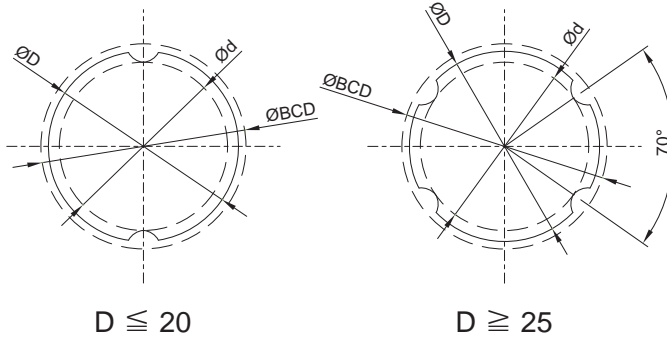

Solid Spline Shaft

Table 3.1.1 Solid Spline Shaft Cross-Sectional Shape

Unit : mm

Stats \ Nominal Diameter	Nominal Diameter									
	6	8	10	13	16	20	25	30	40	50
Inner Diameter Ød	5.25	7.27	8.97	11.82	14.72	18.63	23.43	28.53	37.3	47.05
Outer Diameter ØD h7	6	8	10	13	16	20	25	30	40	50
Mass (kg/m)	0.22	0.39	0.6	1.03	1.56	2.44	3.8	5.49	9.69	15.19
Ball Center ØBCD	6.75	8.77	11.35	14.6	17.5	21.8	27	32.1	43.65	54.2
Tolerance µm	0 -15	0 -15	0 -18	0 -18	0 -18	0 -21	0 -21	0 -25	0 -25	0 -30

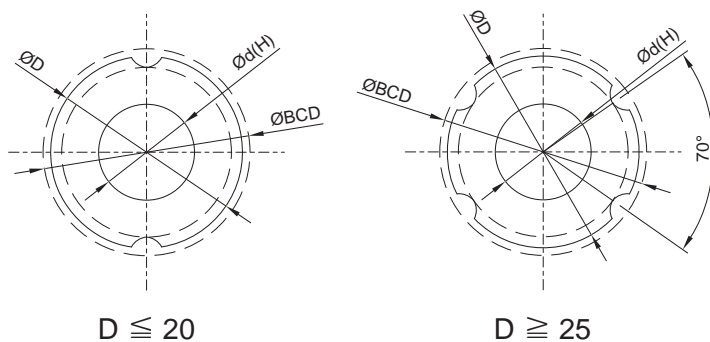

Hollow Spline Shaft

Table 3.1.1 Solid Spline Shaft Cross-Sectional Shape

Unit : mm

Nominal Diameter	6	8	10	13	16	20	25	30	40	50
Stats										
Inner Diameter $\text{Ø}d$	2	3	4	7	8	10	15	16	20	26
Outer Diameter $\text{Ø}D h7$	6	8	10	13	16	20	25	30	40	50
Mass (kg/m)	0.177	0.33	0.506	0.872	1.25	1.82	2.92	3.93	6.75	11.4
Ball Center $\text{Ø}BCD$	6.75	8.77	11.35	14.6	17.5	21.8	27	32.1	43.65	54.2
Tolerance μm	0 -15	0 -15	0 -18	0 -18	0 -18	0 -21	0 -21	0 -25	0 -25	0 -30

TBI MOTION BALL SPLINE

3-1 Nominal Model Code of Ball Spline SL Series

SLF Series Specifications

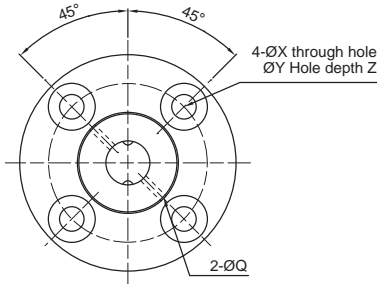

【Two Starts】 Type : 06、10、13

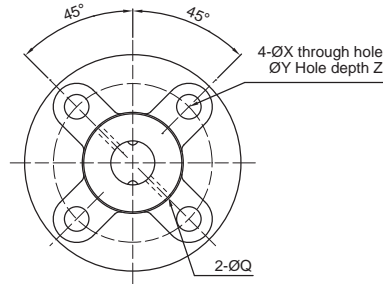

【Two Starts】 Type : 08、16、20

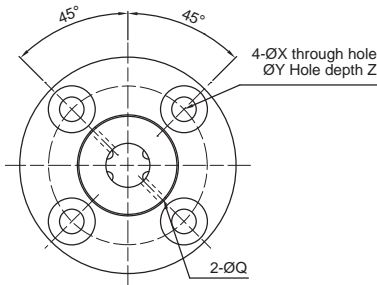

【Four Starts】 Type : 40、50

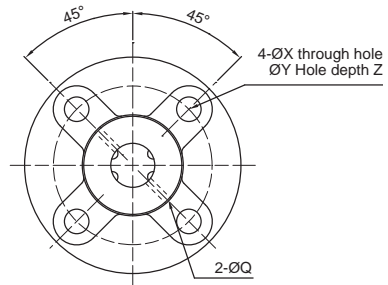

【Four Starts】 Type : 25、30

Model No.	Diameter		Spline Nut Dimension									
	d	Row	D	L	A	B	F	Oil Hole	W	Mounting Hole		
	h7							Q		X	Y	Z
SLF006	6	2	14	25	30	6	7.5	1	22	3.4	6.5	3.5
SLF008	8	2	16	27	32	8	7.5	1.5	24	3.4	6.5	4.5
SLF010	10	2	21	33	42	9	10.5	1.5	32	4.5	8	4
SLF013	13	2	24	36	44	9	11	1.5	33	4.5	8	4.5
SLF016	16	2	31	50	51	10	18	2	40	4.5	8	6
SLF020	20	2	35	56	58	10	18	2	45	5.5	9.5	5.4
SLF025	25	4	42	71	65	13	26.5	3	52	5.5	9.5	8
SLF030	30	4	47	80	75	13	30	3	60	6.6	11	8
SLF040	40	4	64	100	100	18	36	4	82	9	14	12
SLF050	50	4	80	125	124	20	46.5	4	102	11	17.5	12

B

Ball Spline

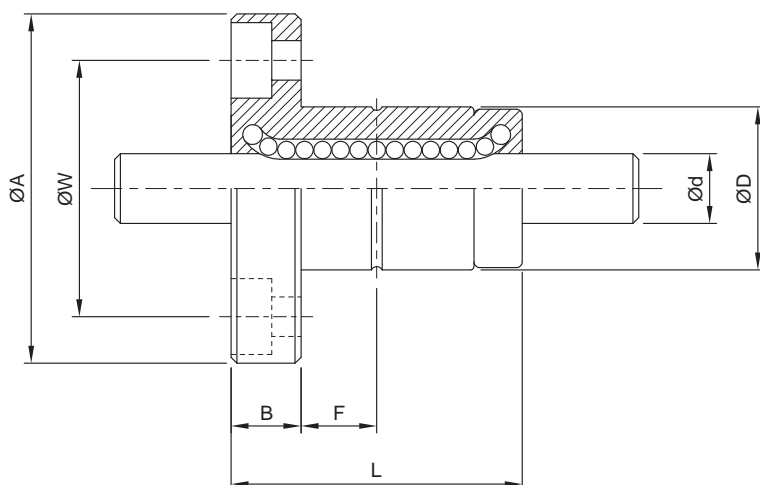

Model No.	Basic Load Rating		Basic Torsion		Static Permissible Moment		Mass	
	C	C ₀	C _T	C _{0T}	M _{A1}	M _{A2}	Spline Nut	Spline Shaft
	kgf	kgf	kgf · m	kgf · m	kgf · m	kgf · m	g	kg/m
SLF006	137	225	0.46	0.76	0.39	3.48	36.7	0.22
SLF008	137	225	0.60	0.99	0.39	3.82	47	0.39
SLF010	285	397	1.62	2.25	0.95	8.53	100	0.60
SLF013	396	540	2.89	3.94	1.50	12.46	117	1.03
SLF016	545	849	4.77	7.43	3.71	26.09	226	1.56
SLF020	724	1109	7.90	12.09	5.53	38.00	303	2.44
SLF025	1003	1593	21.99	43.01	10.35	68.59	458	3.80
SLF030	1160	1980	30.26	62.93	15.68	93.27	633	5.49
SLF040	2972	4033	105.37	176.05	36.59	246.34	1430	9.69
SLF050	4086	5615	179.89	304.35	51.58	428.72	2756	15.19

TBI MOTION BALL SPLINE

3-1 Nominal Model Code of Ball Spline SL Series

SLT Series Specifications

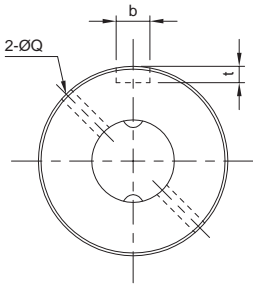

< Two row >

Shaft diameter $d \leq 20$

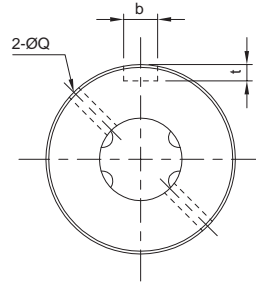

< Four row >

Shaft diameter $d \geq 25$

Model No.	Diameter		Row	Spline Nut Dimension				Keyway Dimensions		
	d	h7		D	L	S	L1	Oil Hole	b	t
								Q	H8	+0.05 ~0
SLT006	6		2	14	25	16.7	10.5	1	2.5	1.2
SLT008	8		2	16	27	15.7	10.5	1.5	2.5	1.2
SLT010	10		2	21	33	20	13	1.5	3	1.5
SLT013	13		2	24	36	23	15	1.5	3	1.5
SLT016	16		2	31	50	34	17.5	2	3.5	2
SLT020	20		2	35	56	39.7	29	2	4	2.5
SLT025	25		4	42	71	50.3	36	3	4	2.5
SLT030	30		4	47	80	60	42	3	4	2.5
SLT040	40		4	64	100	70	52	4	6	3.5
SLT050	50		4	80	125	91	58	4	8	4

B

Ball Spline

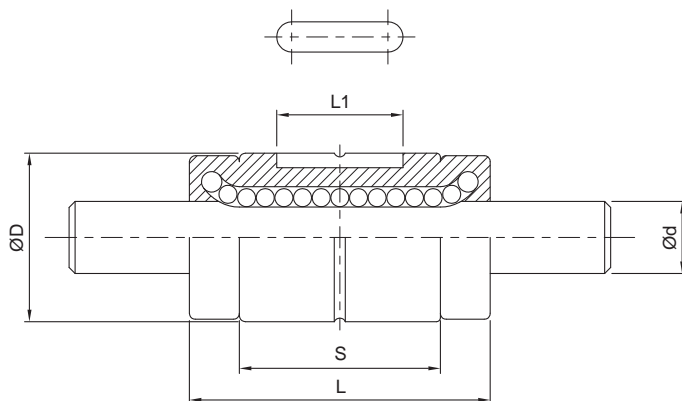

Model No.	Basic Load Rating		Basic Torsion		Static Permissible Moment		Mass	
	C	C ₀	C _T	C _{0T}	M _{A1}	M _{A2}	Spline Nut	Spline Shaft
	kgf	kgf	kgf · m	kgf · m	kgf · m	kgf · m	g	kg/m
SLT006	137	225	0.46	0.76	0.39	3.48	14	0.22
SLT008	137	225	0.60	0.99	0.39	3.82	16	0.39
SLT010	285	397	1.62	2.25	0.95	8.53	37	0.60
SLT013	396	540	2.89	3.94	1.50	12.46	52	1.03
SLT016	545	849	4.77	7.43	3.71	26.09	130	1.56
SLT020	724	1109	7.90	12.09	5.53	38.00	188	2.44
SLT025	1003	1593	21.99	43.01	10.35	68.59	285	3.80
SLT030	1160	1960	30.26	62.93	15.68	93.27	395	5.49
SLT040	2972	4033	105.37	176.05	36.59	264.34	843	9.69
SLT050	4086	5615	179.89	304.35	51.58	428.72	1758	15.19

TBI MOTION BALL SPLINE

3-2 Nominal Model Code of Ball Spline SO Series

■ 3-2-1 Nominal Model Code

TBI MOTION ball Splines is classified into interchangeable and non- interchangeable types. Their dimensions are the same; the only difference between the two types is that for non-interchangeable series, **TBI MOTION** will finish every process in the production line and meet customers' demands. Interchangeable nuts and shafts can be freely exchanged and the standard of the preload is P0. Customers could adjust the preload by changing the steel balls inside of the nut by themselves. It is very convenient for customers to have **TBI MOTION** ball splines in inventory and make the preload and end machining by themselves. **TBI MOTION** is proud of internal quality control process which is under strict international regulation.

Non-interchangeable Type Code :

SOF 008 T2 D N S - 500 - P0 - B2 + N3 N3

①
②
③
④
⑤
⑥
⑦
⑧
⑨
⑩
⑪

①	②	③	④
Spline Nut	Nominal Diameter	Groove	Flange Type
SOF : Flanged SOT : Cylindrical	Unit : mm	T2 : 2 Rows	D : Flange cutting (No Symbol When It is Without the Flange)

⑤	⑥	⑦
Accuracy Grade of Spline Shaft	Spline Shaft Type	Overall Length of Spline Shaft
N : Normal H : High P : Precision	S : Solid H : Hollow	Unit : mm

⑧	⑨	⑩
Preload Value	Number of Spline Nut	Nut Surface Treatment
P0 : No preload P1 : Light preload	(Leave blank if only one nut is required) Ex : Two install spline nuts on a shaft : B2	S : Standard B1 : Black Oxidation N1 : Hard Chrome Plating P : Phosphating N3 : Nickel Plating N4 : Raydent N5 : Chrome Plating

⑪
Shaft Surface Treatment
S : Standard
B1 : Black Oxidation
N1 : Hard Chrome Plating
P : Phosphating
N3 : Nickel Plating
N4 : Raydent
N5 : Chrome Plating

※No symbol required when plating is not needed.

Nominal Model Code for Interchangeable SO Type

Interchangeable Type of Spline Nut :

SOF 013 T2 D + N3

① ② ③ ④ ⑤

①	②	③	④
Spline Nut	Nominal Diameter	Groove	Flange Type
SOF : Flanged SOT : Cylindrical	Unit : mm	T2 : 2 Rows	N : Round (No Symbol When It is Without the Flange)
⑤			
Nut Surface Treatment			
S : Standard			
B1 : Black Oxidation			
N1 : Hard Chrome Plating			
P : Phosphating			
N3 : Nickel Plating			
N4 : Raydent			
N5 : Chrome Plating			

Interchangeable Type of Spline Shaft :

SK 008 T2 N S - 500 + N3

① ② ③ ④ ⑤ ⑥ ⑦

①	②	③	④
Nominal Model Code	Nominal Diameter	Groove	Accuracy Grade of Spline Shaft
	Unit : mm	T2 : 2 Rows	N : Normal
⑤			
Spline Shaft Type			
S : Solid			
H : Hollow			
⑥			
Overall Length of Spline Shaft			
Unit : mm			
⑦			
Nut Surface Treatment			
S : Standard			
B1 : Black Oxidation			
N1 : Hard Chrome Plating			
P : Phosphating			
N3 : Nickel Plating			
N4 : Raydent			
N5 : Chrome Plating			

TBI MOTION BALL SPLINE

3-2 Nominal Model Code of Ball Spline SO Series

SOF, SOT Spline Shaft Cross-Sectional Shape

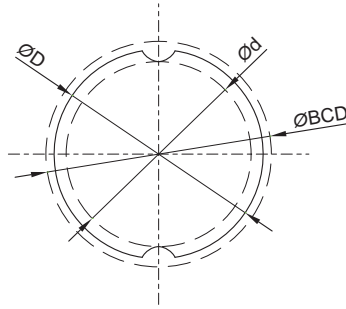

Solid Spline Shaft

Table 3.2.1 Solid Spline Shaft Cross-Sectional Shape

Unit : mm

Nominal Diameter	8	10	12	15	20	25
Stats						
Inner Diameter Ød	7	8.9	10.9	11.6	15.7	19.4
Outer Diameter ØD h7	8	10	12	13.6	18.2	22.6
Mass(kg/m)	0.39	0.605	0.875	1.11	2.02	3.1
Ball Center ØBCD	9.3	11.6	13.6	15	20	25
Tolerance µm	0 -15	0 -18	0 -18	0 -18	0 -21	0 -21

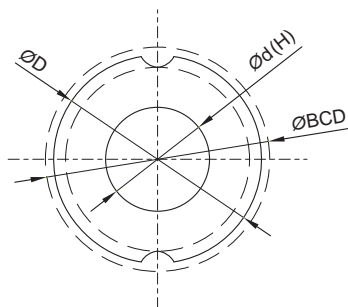

Hollow Spline Shaft

Table 3.2.2 Hollow Spline Shaft Cross-Sectional Shape

Unit : mm

Nominal Diameter	8	10	12
Stats			
Inner Diameter Ød	3	4	6
Outer Diameter ØD h7	8	10	12
Mass(kg/m)	0.33	0.51	0.66
Ball Center ØBCD	9.3	11.6	13.6
Tolerance µm	0 -15	0 -18	0 -18

TBI MOTION BALL SPLINE

3-2 Nominal Model Code of Ball Spline SO Series

SOF Series Specifications

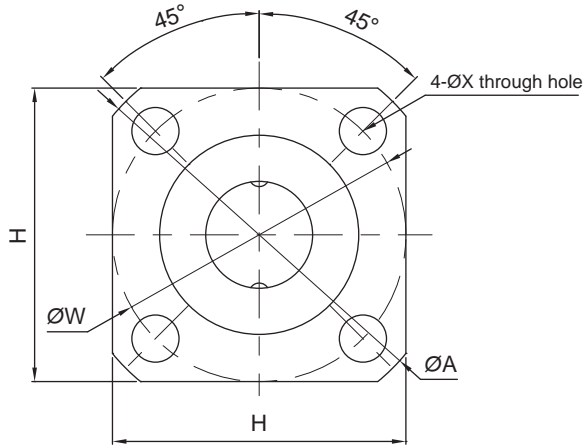

Model No.	Diameter		Row	Spline Nut Dimension							Mounting Hole
	d	h7		D	L	A	B	E	F	W	X
	SOF008	8		2	15	25	28	3.8	5.2	22	22
SOF010	10	2	19	30	36	4.1	5.9	28	28	4.5	
SOF012	12	2	21	35	38	4	6	30	30	4.5	
SOF015	13.6	2	23	40	40	4.5	6.5	31	32	4.5	
SOF020	18.2	2	30	50	46	5.5	8.5	35	38	4.5	
SOF025	22.6	2	37	60	57	6.6	10.4	43	47	5.5	

B

Ball Spline

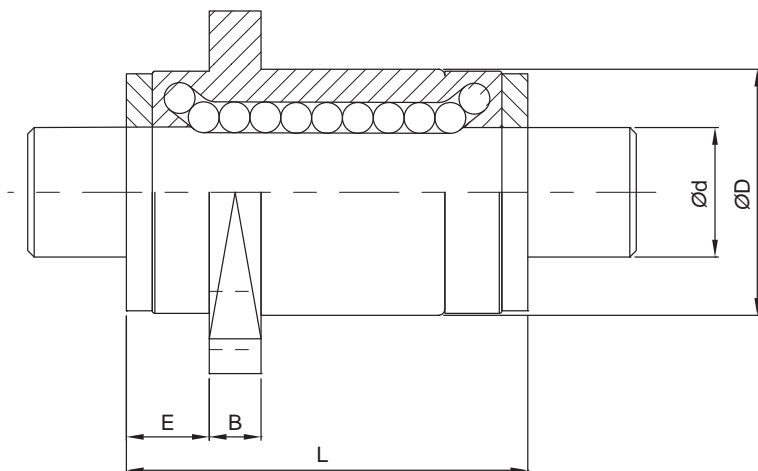

Model No.	Basic Load Rating		Basic Torsion		Static Permissible Moment		Mass	
	C	C ₀	C _T	C _{0T}	M _{A1}	M _{A2}	Spline Nut	Spline Shaft
	kgf	kgf	kgf · m	kgf · m	kgf · m	kgf · m	g	kg/m
SOF008	121	136	0.56	0.63	0.34	2.24	23.5	0.39
SOF010	192	219	1.11	1.27	0.71	4.23	45	0.61
SOF012	222	274	1.51	1.87	1.08	6.02	59	0.88
SOF015	426	619	3.19	4.65	2.83	15.49	77	1.11
SOF020	673	922	6.73	9.22	4.95	29.36	150	2.02
SOF025	1142	1458	14.17	18.14	9.46	56.17	255	3.10

TBI MOTION BALL SPLINE

3-2 Nominal Model Code of Ball Spline SO Series

SOT Series Specifications

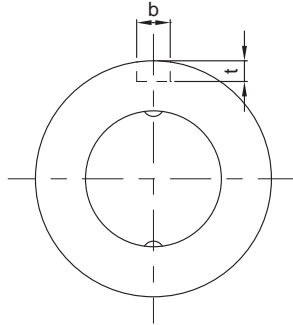

< Two row >

Shaft diameter

Model No.	Diameter	Row	Spline Nut Dimension				Keyway Dimensions	
	d		D	L	S	L1	b	t
	h7						H8	+0.05 ~ 0
SOT008	8	2	15	25	14.6	8.5	2.5	1.5
SOT010	10	2	19	30	18.2	11	3	1.8
SOT012	12	2	21	35	23	15	3	1.8
SOT015	13.6	2	23	40	27	20	3.5	2
SOT020	18.2	2	30	50	33	26	4	2.5
SOT025	22.6	2	37	60	39.2	29	5	3

B

Ball Spline

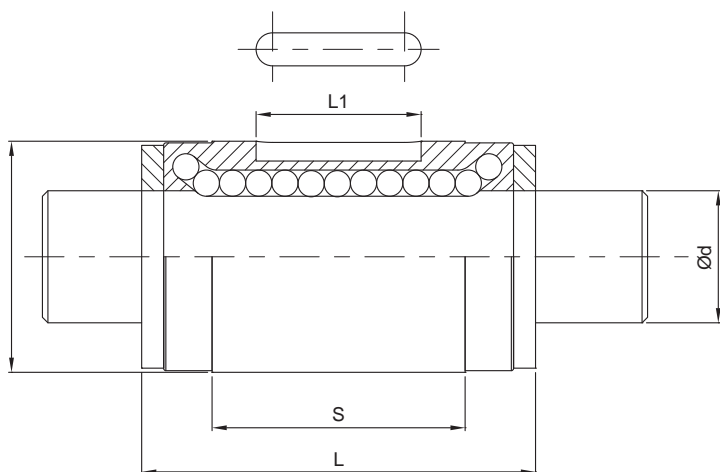

Model No.	Basic Load Rating		Basic Torsion		Static Permissible Moment		Mass	
	C	C ₀	C _T	C _{0T}	M _{A1}	M _{A2}	Spline Nut	Spline Shaft
	kgf	kgf	kgf · m	kgf · m	kgf · m	kgf · m	g	kg/m
SOT008	121	136	0.56	0.63	0.34	2.24	15.9	0.39
SOT010	192	219	1.11	1.27	0.71	4.23	31.5	0.61
SOT012	222	274	1.51	1.87	1.08	6.02	44	0.88
SOT015	426	619	3.19	4.65	2.83	15.49	59.5	1.11
SOT020	673	922	6.73	9.22	4.95	29.36	130	2.02
SOT025	1142	1458	14.17	18.14	9.46	56.17	220	3.10