

Single Axis Actuator



1-1 Structure and Features of TBI MOTION Actuator	E02
1-1-1 Basic Structure of TBI MOTION Actuator.....	E02
1-2 Features of the Single Axis Actuator	E03
1-2-1 Advantages of Modularized Design	E03
1-2-2 Loads from all Directions	E03
1-2-3 High Rigidity.....	E03
1-2-4 High Accuracy, Saving Space	E03
1-3 Purchase of Peripherals	E04
1-3-1 About the Single Axis Actuator.....	E04
1-3-2 KP Series Nominal Model Codes.....	E06
1-4 Accuracy Design	E08
1-4-1 Accuracy Level.....	E08
1-5 Maximum Speed	E09
1-5-1 Maximum Length and Maximum Moving Speed.....	E09
1-6 Calculation of Service Life	E10
1-6-1 Static Safety Factor	E10
1-6-2 Service Life.....	E11
1-7 Lubrication	E13
1-7-1 Notice on Lubrication.....	E13
1-8 KP Product Series	E14
KP26 (Standard Type).....	E14
KP26(Standard Type with Protective Cap).....	E15
KP26(Low-Assembly)	E16
KP33(Standard Type)	E17
KP33(Standard Type with Protective Cap).....	E18
KP33(Low-Assembly).....	E19
KP33(Light-Load Type)	E20
KP33(Light-Load Type with Protective Cap).....	E21
KP33(Light-Load Type, Low-Assembly).....	E22
KP46(Standard Type)	E23
KP46(Standard Type with Protective Cap).....	E24
KP46(Low-Assembly).....	E25
KP46(Light-Load Type)	E26
KP46(Light-Load Type with Protective Cap).....	E27
KP46(Light-Load Type, Low-Assembly).....	E28
1-9 The Adapting Flange of the Motor Base and the Motor	E29
1-9-1 List of Suitable Motors.....	E29
1-9-2 The Adapting Flange of the Motor Base and the Motor.....	E33
1-9-3 Sensor.....	E38
1-9-4 Sensor Track	E39

ABOUT SINGLE AXIS ACTUATOR

1-1 Structure and Features of *TBI MOTION* Actuator

■ 1-1-1 Basic Structure of *TBI MOTION* Actuator

Adopts the advantages of the TBI Motion linear guides and screws then designs the nut and block into an integral mechanism. With the highly rigid U-Rail track optimized section, it minimize the required space and the time for assembly. This ensures its demand for high rigidity and high accuracy. The ball rolling face adopts an excellent design of a 2-row Gothic arc and 45° contact angle. Moreover, the design allows the X-axis and Y-axis to bear loads from all directions.

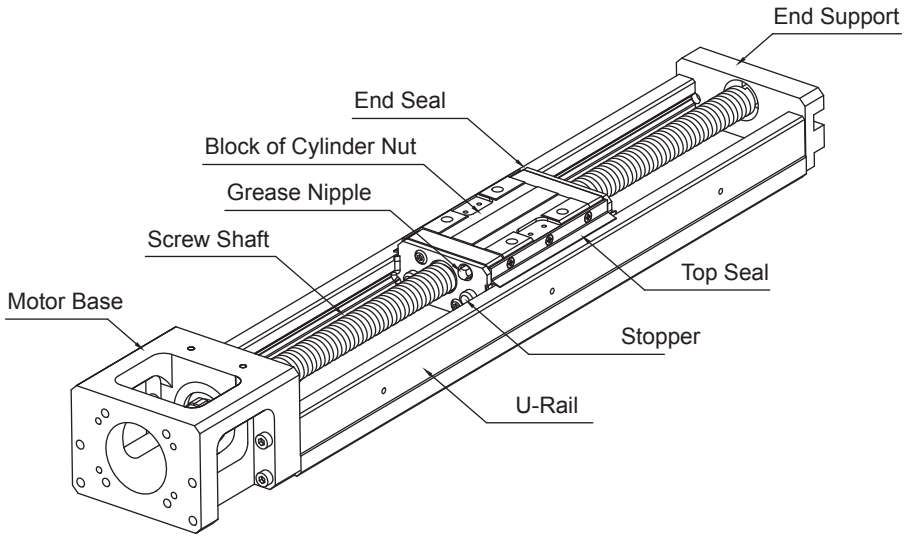

Fig 1.1.1 Structure of the Single Axis Actuator body



1-2 Features of the Single Axis Actuator

1-2-1 Advantages of Modularized Design

The combination of ball screw and linear guide makes simple installation possible, shorten replacement time and prolong service life. The traditional linear platform device requires guides and drive elements. It features easy-assembly, high rigidity, small size, etc. Moreover it saves more time and space for clients.

1-2-2 Loads from all Directions

The contact surface of ball and groove is designed to be 45° and can bear the same rated load of any type of installation, radially, reverse-radially or laterally.

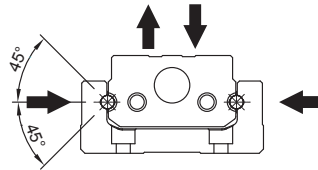

Fig 1.2.1

1-2-3 High Rigidity

The Ansys optimized U-Rail track design allows the track to be light weight and accomplish higher rigidity at cantilever load to achieve a perfect balance between rigidity and volume.

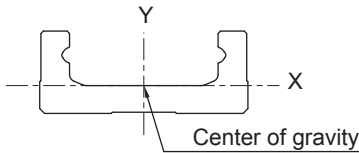

Fig 1.2.2

Table 1.1.1

Unit : mm⁴

Model	I _x	I _y
KP26	1.116x10 ⁴	1.393x10 ⁵
KP33	3.542x10 ⁴	3.243x10 ⁵
KP46	1.256x10 ⁵	1.305x10 ⁶

(Note) I_x : 2nd moment revolves of area around the X axis ;
I_y : 2nd moment revolves of area around the Y axis.

1-2-4 High Accuracy, Saving Space

The variable loading minimizes the friction to meet a high accuracy demand. A combination of the nut with the slide makes space saving and an optimized allocation possible.

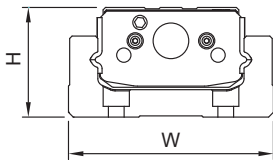

Fig 1.2.3

Table 1.1.2

Unit : mm

Model	H	W
KP26	26	50
KP33	33	60
KP46	46	86

ABOUT SINGLE AXIS ACTUATOR

1-3 Purchase of Peripherals

■ 1-3-1 About the Single Axis Actuator

To satisfy various industrial operations, the KP Single Axis Actuator can additionally purchase a dust cap, a dust expansion sleeve, a sensor, a motor adapting flange, etc.

- Dust Cap & Dust Expansion Sleeve : prevent foreign objects from entering and ensure the overall accuracy, service life and smoothness.
- Motor Adapting Flange : fit for different motors and secured on the Single Axis Actuator.
- Sensor : a safety protection device which assists with slide positioning, original start up and traveling.

Components and Accessories of the Single Axis Actuator

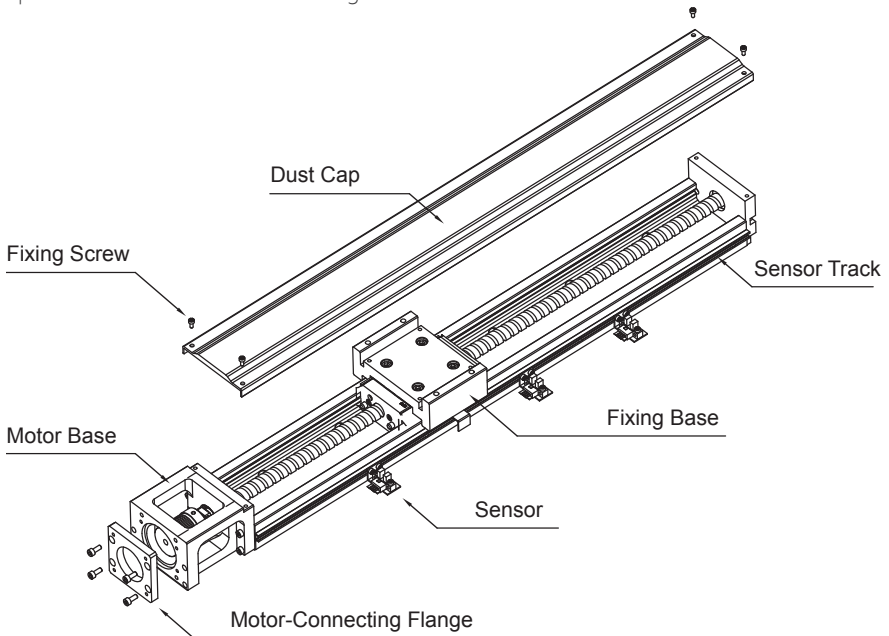

Fig 1.3.1 Components and Accessories

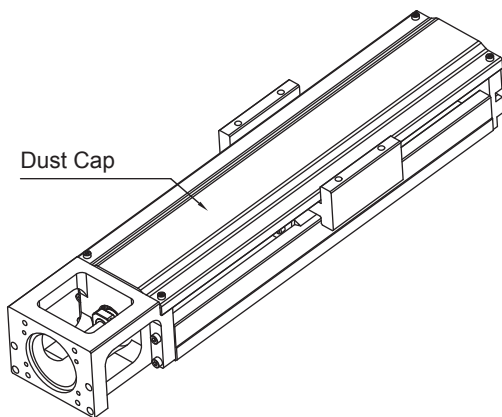

Fig 1.3.2 Dust Cap

ABOUT SINGLE AXIS ACTUATOR

1-3 Purchase of Peripherals

■ 1-3-2 KP Series Nominal Model Codes

KP 026 02 K N - 2 - 300 - P + M01 F01 C01 S01

① ② ③ ④ ⑤ ⑥ ⑦ ⑧ ⑨ ⑩ ⑪ ⑫

①	②	③	④
Nominal Model	Size	Ball Screw Travel	Nut Type
KP	26, 33, 46	KP26 : 2 KP33 : 5, 10 KP46 : 10, 20	K, V : Standard X : Special (K No. 26, V Nos. 33 & 46)

⑤	⑥	⑦	⑧
Carriage Length	No. of Slides	Track Length	Accuracy Level
N : Standard S : Light Load	1, 2	Unit : mm	P : Ground H : High N : Rolled

⑨	⑩	⑪
Motor	Motor Adapting Flange	Dust Cap
□ : None M : Motor (ref. E29~32)	(ref. E33~37)	□ : None C01 : Dust Cap C02 : Dust Expansion Sleeve

⑫
Include Sensor
□ : Standard no Sensor
S01~03 : Only Sensor (ref. E38, Table 1.9.6)
S04~06 : Omron SX671
S07~09 : Omron SX674
S10~12 : SUNX GX-F12A
S13~15 : SUNX GX-F12A-P

※ When choosing the Single Axis Actuator, each set has 3 set of sensors included. Please consult **TBI MOTION** for special requirements.



Single Axis Actuator

KP Load Specs

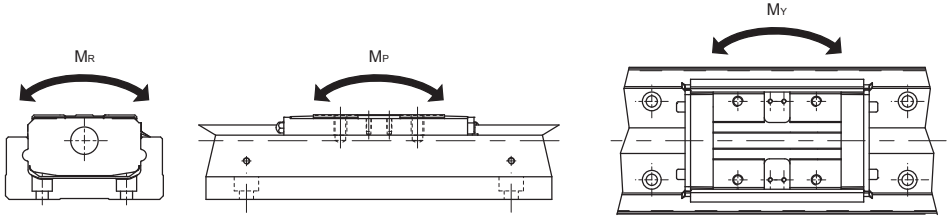

Model No.		Ball Screw				Linear Guide															
		d	I	Ca (N)	Coa (N)	Ca (N)		Coa (N)		Static Permissible Moment											
						N	S	N	S	MP(N-m)				MY(N-m)				MR(N-m)			
										LS	LD	NS	ND	LS	LD	NS	ND	LS	LD	NS	ND
KP2602	Ground	8	2	1829	3590	8058	-	10578	-	62	481	-	-	62	481	-	-	180	360	-	-
	High			1829	3590																
	Rolled			1555	3051																
KP3305	Ground	12	5	3996	7249	11201	8441	14839	9893	108	720	49	413	108	720	49	413	310	620	207	413
	High			3996	7249																
	Rolled			3396	6161																
KP3310	Ground	12	10	2696	4592	11201	8441	14839	9893	108	720	49	413	108	720	49	413	310	620	207	413
	High			2696	4592																
	Rolled			2292	3903																
KP4610	Ground	15	10	5876	11131	39886	33246	56974	44313	610	4021	307	2517	610	4021	307	2517	1728	3456	1344	2688
	High			5876	11131																
	Rolled			-	-																
KP4620	Ground	15	20	3790	7033	39886	33246	56974	44313	610	4021	307	2517	610	4021	307	2517	1728	3456	1344	2688
	High			3790	7033																
	Rolled			-	-																

ABOUT SINGLE AXIS ACTUATOR

1-4 Accuracy Design

■ 1-4-1 Accuracy Level

The accuracy of the Single Axis Actuator is split into Ground (P), High (H) and Rolled (N), as shown below.

Table 1.4.1

Unit : mm

Model	Track Length	Positioning Repeatability			Positioning Accuracy			Positioning Parallelism			Max. Starting Torque (N-cm)			
		Ground	High	Rolled	Ground	High	Rolled	Ground	High	Rolled	Ground	High	Rolled	
KP26	150	±0.003	±0.005	±0.01	0.020	0.060	-	0.010	0.025	-	4	2	2	
	200													
	250													
	300													
KP33	150	±0.003	±0.005	±0.01	0.020	0.060	-	0.010	0.025	-	15	7	7	
	200													
	300													
	400													
	500	±0.003	±0.005	±0.01	0.025	0.100	-	0.015	0.035	-				
	600													
KP46	340	±0.003	±0.005	-	0.025	0.100	-	0.015	0.035	-	15	10	-	
	440													
	540													
	640													
	740	±0.003	±0.005	-	0.030	0.120	-	0.020	0.040	-				17
	940	±0.003	±0.005	-	0.040	0.150	-	0.030	0.050	-				25



Single Axis Actuator

1-5 Maximum Speed

■ 1-5-1 Maximum Length and Maximum Moving Speed

Restricted by the critical speed and DN value of the screw, the Single Axis Robot's max. moving speed is shown below.

Table 1.4.1

Model	Ball Screw Lead (mm)	Ball Screw Lead (mm)	Speed (mm/sec)		
			Ground	High	Rolled
KP26	02	150	270	270	270
		200	270	270	270
		250	270	270	270
		300	270	270	270
KP33	05	150	550	550	390
		200	550	550	390
		300	550	550	390
		400	550	550	390
		500	550	550	390
		600	340	340	340
	10	150	1100	1100	790
		200	1100	1100	790
		300	1100	1100	790
		400	1100	1100	790
		500	1100	1100	790
		600	670	670	670
KP46	10	340	740	740	520
		440	740	740	520
		540	740	740	520
		640	740	740	520
		740	740	740	520
		940	610	610	430
	20	340	1480	1480	1050
		440	1480	1480	1050
		540	1480	1480	1050
		640	1480	1480	1050
		740	1480	1480	1050
		940	1220	1220	870

ABOUT SINGLE AXIS ACTUATOR

1-6 Calculation of Service Life

■ 1-6-1 Static Safety Factor

1. Analyze the Track :

When calculating the load of a track, first we must assess the average load required for the service life, as well as the maximum load required at a static rating. In particular, a travel distance is too short may cause a big moment due to cantilever load, leading to an excessive load.

$$f_s = \frac{C_o}{P_{\max}}$$

f_s : Static safety factor

C_o : Basic static load rating (N)

P_{\max} : Max. load (N)

2. Analyze the Support End of the Ball Screw : Single Axis Actuator takes extra axial force due to the inertia force caused by start-stop therefore the static safety factor of Single Axis Actuator must be considered.

$$f_s = \frac{C_{oa}}{F_{\max}}$$

f_s : Static safety factor

C_{oa} : Basic static load rating (N)

F_{\max} : Max. load (N)

Table 1.6.1 Static Safety Factor f_s

Machines that use the linear motion system	Load conditions	Lower limit of f_s
Integrated industrial machines	No vibration & impact	1.0 - 3.5
	With vibration & impact	2.0 - 5.0

※The reference value of the static safety factor may defer depending on the environment, the lubrication, the accuracy or rigidity of installation.

【 f_c : Contact Factor】

With KP-LD, 2 internal slides are used close to each other, the contact factor multiplied by the basic static load rating is 0.81 . Please refer to A10. Table 1.3.2 (when used closely, the number of slides is 1 or 2).

【 f_w : Load Factor】

Please refer to A10. Table 1.3.3.

When Single Axis Actuator operating with load, the load distribution on the track becomes uneven and partial loads get heavier as well. At this point, multiply the moment factor that equivalent to the moment value in Table 1.6.2 for load calculating.

Model	Equivalentfactor $K_a(\text{mm}^{-1})$	Equivalentfactor $K_b(\text{mm}^{-1})$	Equivalentfactor $K_c(\text{mm}^{-1})$
KP26-N-LS	1.70×10^{-1}	1.70×10^{-1}	5.88×10^{-2}
KP26-N-LD	2.19×10^{-2}	2.19×10^{-2}	5.88×10^{-2}
KP33-S-NS	1.37×10^{-1}	1.37×10^{-1}	4.79×10^{-2}
KP33-S-ND	2.06×10^{-2}	2.06×10^{-2}	4.79×10^{-2}
KP33-N-LS	2.0×10^{-1}	2.0×10^{-1}	4.79×10^{-2}
KP33-N-LD	2.39×10^{-2}	2.39×10^{-2}	4.79×10^{-2}
KP46-S-NS	1.44×10^{-1}	1.44×10^{-1}	3.29×10^{-2}
KP46-S-ND	1.76×10^{-2}	1.76×10^{-2}	3.29×10^{-2}
KP46-N-LS	9.33×10^{-2}	9.33×10^{-2}	3.29×10^{-2}
KP46-N-LD	1.41×10^{-2}	1.41×10^{-2}	3.29×10^{-2}

K_a : Moment equivalent coefficient of trimming.

K_b : Moment equivalent coefficient of shifting.

K_c : Moment equivalent coefficient of rolling.

■ 1-6-2 Service Life

KP is constituted by a track, a ball screw and supporting bearings. The life of each component part can be calculated as follows :

1. Analyze the track :

Rating Life

$$L = \left(\frac{f_c \times C}{f_w \times P_c} \right)^3 \cdot 50 \text{ km}$$

L : Rated Life (km)

C : Basic Dynamic Rated Load (N)

P_c : Value of the Calculated Load (N)

f_c : Contact Factor

f_w : Load Factor

ABOUT SINGLE AXIS ACTUATOR

1-6 Calculation of Service Life

In a KP-LD, 2 internal slides are used close to each other and when a moment is generated, refer to Table 1.6.2, multiply the equivalent factor with the load moment, having an equivalent load.

$$P_m = K \times M$$

P_m : Equivalent load of the slide(kgf)

K : Moment factor of equivalence (mm)

M : Moment load (kgf×mm)

When apply a M_c moment on a KP-LD :

$$P_m = \frac{K_c \cdot M_c}{2}$$

Apply a radial load (P) and a moment on a KP-LD at the same time :

$$P_E = P + P_m$$

P_E : Total radial load of equivalence (N)

【Service Life】

After a rated service life is calculated, service life can be calculated by using the following formula(Under the circumstances that the travel distance and the number of reciprocating cycles per minute are stable).

$$L_h = \frac{L \cdot 10^6}{2 \cdot l_s \cdot N_1 \cdot 60}$$

L_h : Service life (h)

l_s : Distance of travel (mm)

N_1 : No. of reciprocating cycles per minute (min^{-1})

2. Analyze the supporting end of ball screw :

Rating Life

$$L = \left(\frac{C_a}{f_w \cdot F_a} \right)^3 \cdot 10^6$$

L : Service life (rev)

C_a : Basic dynamic rated load (N)

F_a : Value of calculated load (N)

f_w : Load factor (refer to E09. Table 1.6.1)



1-7 Calculation of Service Life/ Lubrication

【Service Life】

After a rated service life is calculated, service life can be calculated by using the following formula (provided that the travel distance and the number of reciprocating cycles per minute are not changed).

$$L_h = \frac{L \cdot l}{2 \cdot l_s \cdot N_1 \cdot 60}$$

L_h : Service life (h)

l_s : Distance of travel (mm)

N_1 : No. of reciprocating cycles per minute (min^{-1})

l : Screw lead (mm)

■ 1-7-1 Notice on Lubrication

Lubrication is essential to Single Axis Actuator, otherwise the friction increase and it may be the main factor of service life shortening. It is suggested that every 100km travel distance Single Axis Actuator should be lubricated through the grease nipple on the slide. Grease only applies to the working environment which is slower than 60/mins and cooling is not required.

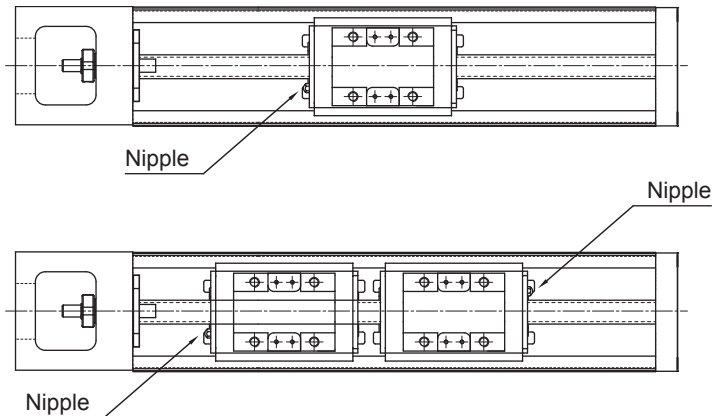

ABOUT SINGLE AXIS ACTUATOR

1-8 KP Product Series

KP26 (Standard Type)

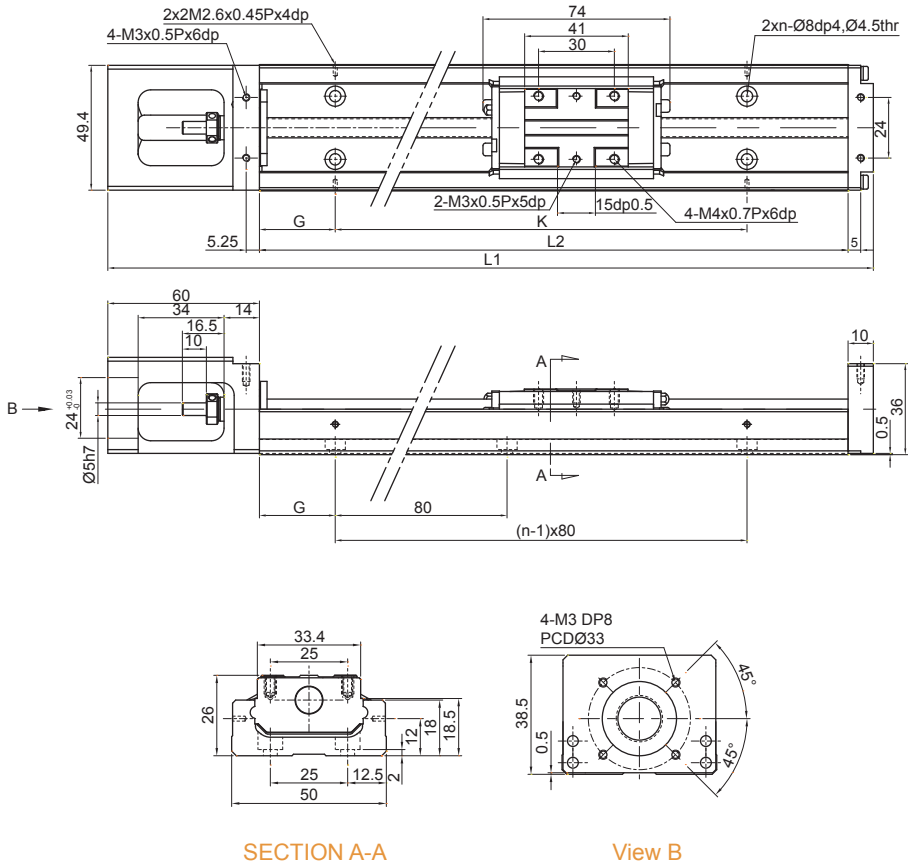

Track length L2(mm)	Overall length L1(mm)	Max.travel(mm)		G(mm)	K(mm)	n	Total weight(kg)	
		LS	LD				LS	LD
150	220	73	-	35	80	2	1	-
200	270	123	54	20	160	3	1.2	1.4
250	320	173	104	45	160	3	1.4	1.6
300	370	223	154	30	240	4	1.6	1.8

※LS slide base : with one slide base, LD slide base : with two slide bases.

KP26 (Standard Type with Protective Cap)

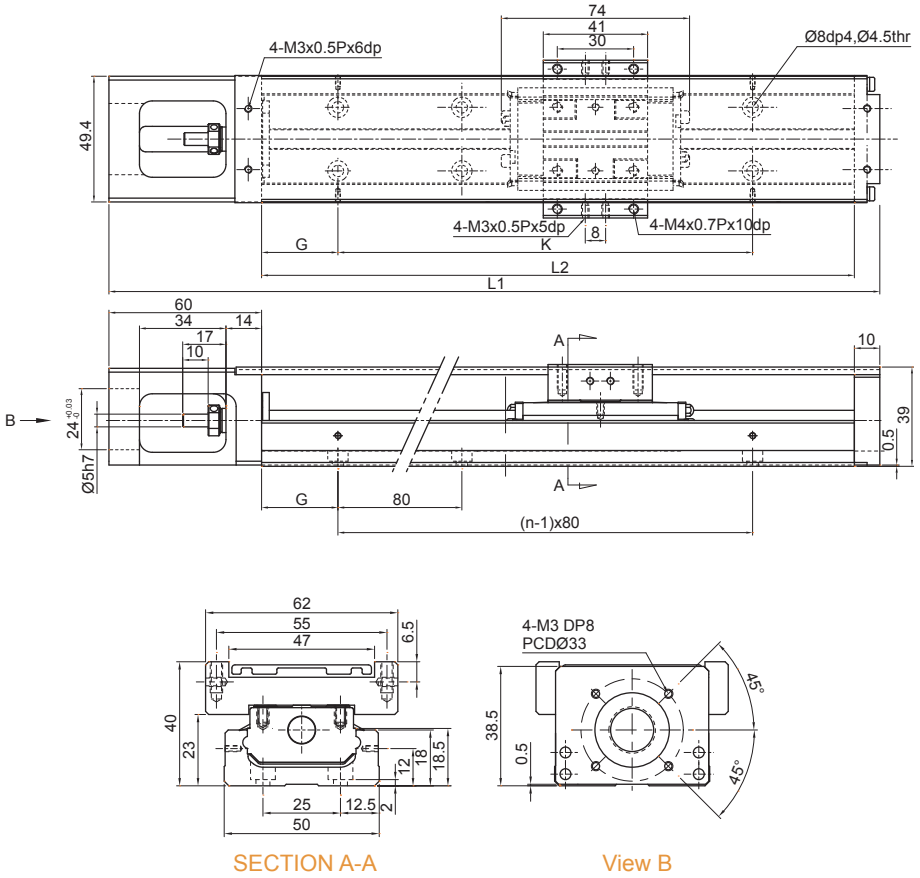

Single Axis Actuator

Track length L2(mm)	Overall length L1(mm)	Max.travel(mm)		G(mm)	K(mm)	n	Total weight(kg)	
		LS	LD				LS	LD
150	220	73	-	35	80	2	1.1	-
200	270	123	54	20	160	3	1.3	1.5
250	320	173	104	45	160	3	1.5	1.8
300	370	223	154	30	240	4	1.8	2.0

※ LS slide base : with one slide base, LD slide base : with two slide bases.

ABOUT SINGLE AXIS ACTUATOR

1-8 KP Product Series

KP26 (Low-Assembly)

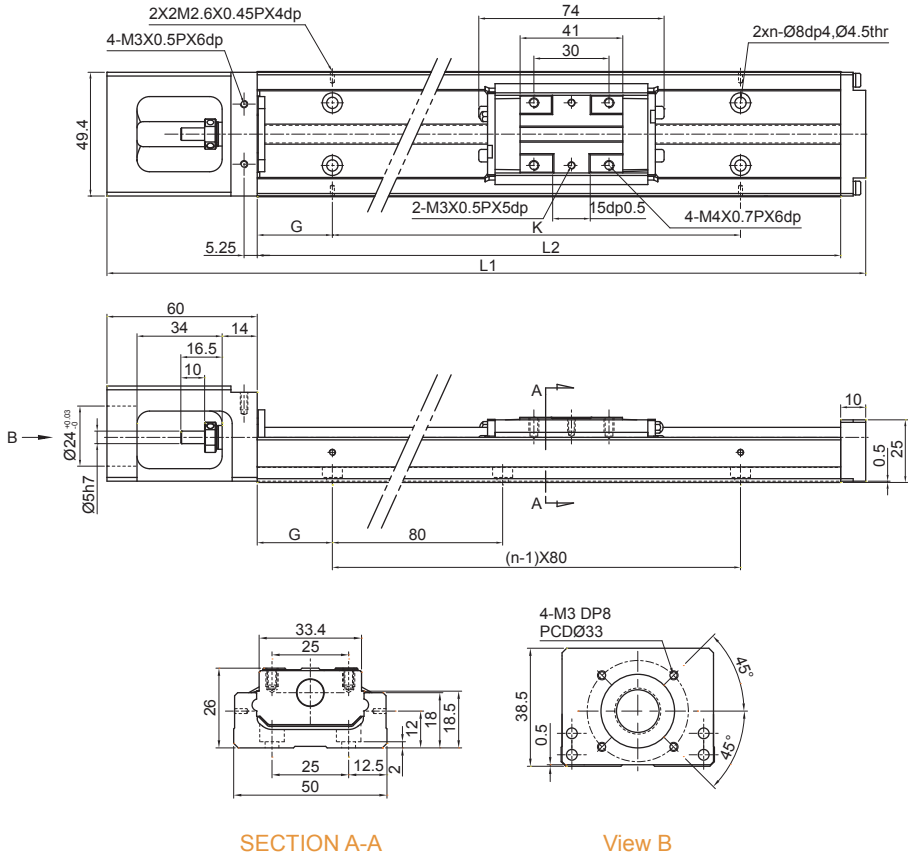

Track length L2(mm)	Overall length L1(mm)	Max.travel(mm)		G(mm)	K(mm)	n	Total weight(kg)	
		LS	LD				LS	LD
150	220	73	-	35	80	2	1	-
200	270	123	54	20	160	3	1.2	1.4
250	320	173	104	45	160	3	1.4	1.6
300	370	223	154	30	240	4	1.6	1.8

※LS slide base : with one slide base, LD slide base : with two slide bases.

KP33 (Standard Type)

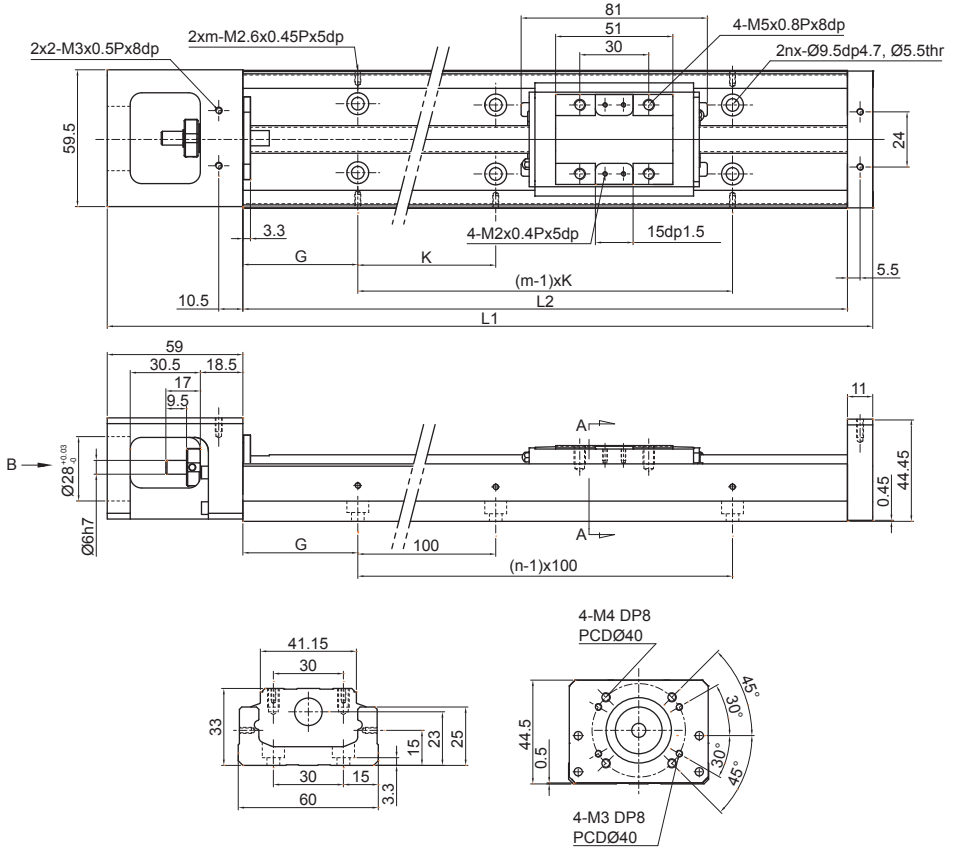

SECTION A-A

View B

Track length L2(mm)	Overall length L1(mm)	Max.travel(mm)		G(mm)	K(mm)	n	m	Total weight(kg)	
		LS	LD					LS	LD
150	220	63.5	-	25	100	2	2	1.5	-
200	270	113.5	36.5	50	100	2	2	1.8	-
300	370	213.5	136.5	50	200	3	2	2.4	2.7
400	470	313.5	236.5	50	100	4	4	3	3.3
500	570	413.5	336.5	50	200	5	3	3.6	3.9
600	670	513.5	436.5	50	100	6	6	4.2	4.6

※ LS slide base : with one slide base, LD slide base : with two slide bases.
 ※ Additional collar for motor side shaft end is available, if it is required please contact TBI MOTION.

ABOUT SINGLE AXIS ACTUATOR

1-8 KP Product Series

KP33 (Standard Type with Protective Cap)

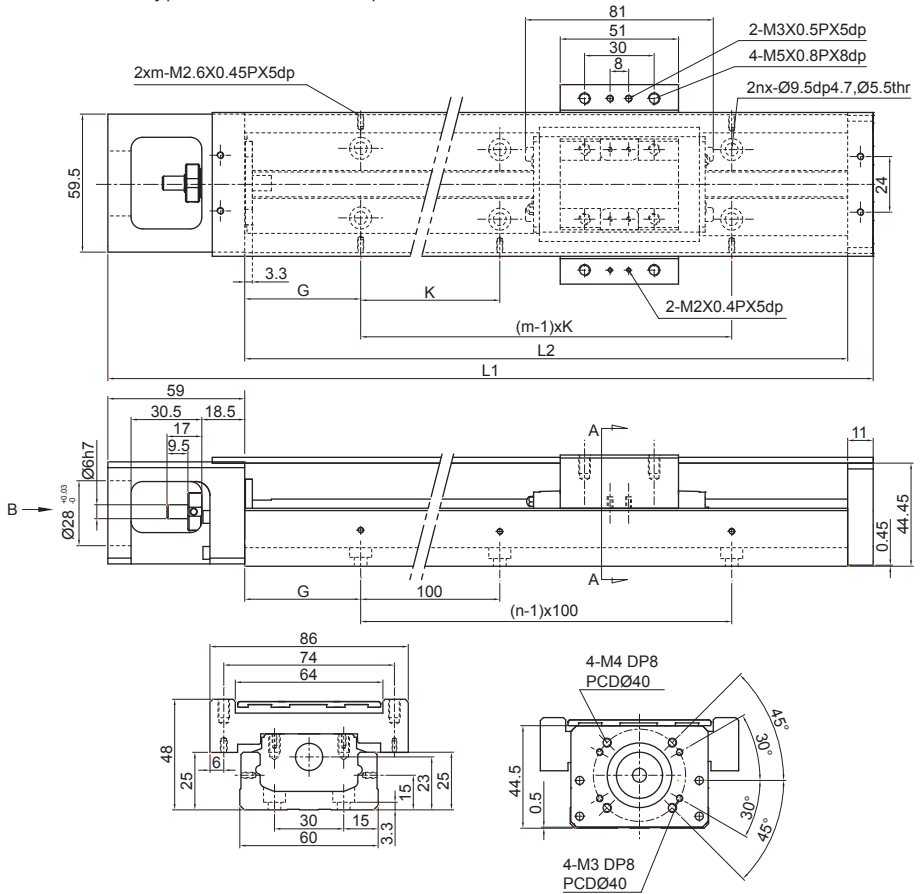

SECTION A-A

View B

Track length L2 (mm)	Overall length L1 (mm)	Max. travel (mm)		G(mm)	K(mm)	n	m	Total weight (kg)	
		LS	LD					LS	LD
150	220	63.5	-	25	100	2	2	1.5	-
200	270	113.5	36.5	50	100	2	2	1.8	-
300	370	213.5	136.5	50	200	3	2	2.4	2.7
400	470	313.5	236.5	50	100	4	4	3	3.3
500	570	413.5	336.5	50	200	5	3	3.6	3.9
600	670	513.5	436.5	50	100	6	6	4.2	4.6

※ LS slide base : with one slide base, LD slide base : with two slide bases.

※ Additional collar for motor side shaft end is available, if it is required please contact TBI MOTION.



Single Axis Actuator

KP33 (Low-Assembly)

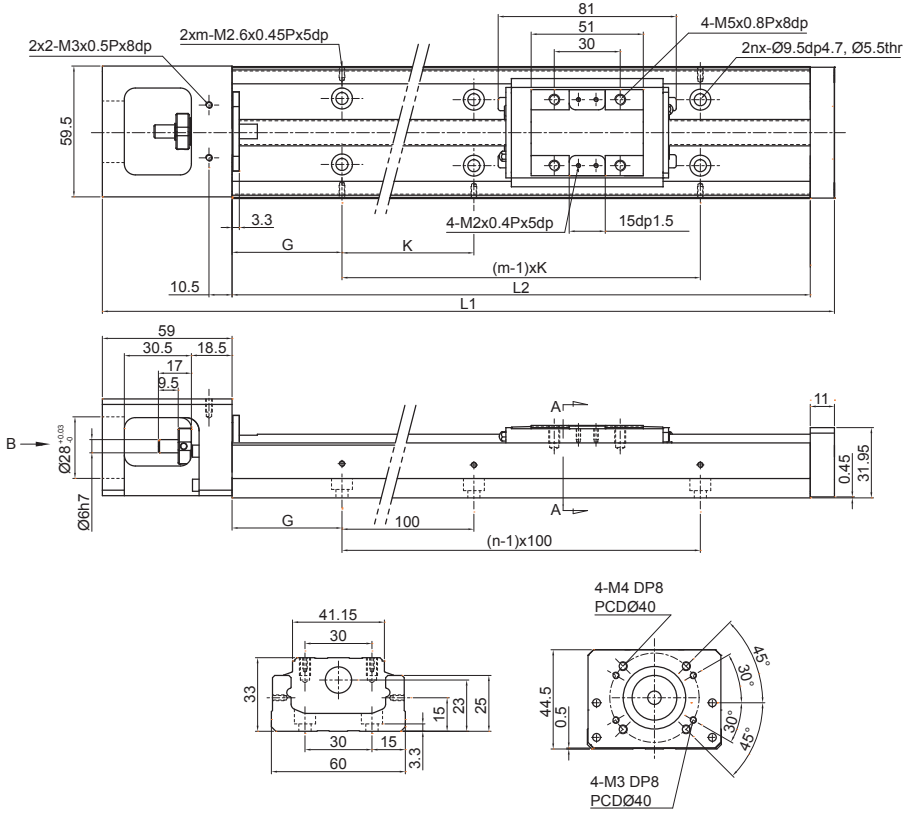

SECTION A-A

View B

Track length L2 (mm)	Overall length L1 (mm)	Max. travel (mm)		G(mm)	K(mm)	n	m	Total weight (kg)	
		LS	LD					LS	LD
150	220	63.5	-	25	100	2	2	1.5	-
200	270	113.5	36.5	50	100	2	2	1.8	-
300	370	213.5	136.5	50	200	3	2	2.4	2.7
400	470	313.5	236.5	50	100	4	4	3	3.3
500	570	413.5	336.5	50	200	5	3	3.6	3.9
600	670	513.5	436.5	50	100	6	6	4.2	4.6

※ LS slide base : with one slide base, LD slide base : with two slide bases.
 ※ Additional collar for motor side shaft end is available, if it is required please contact TBI MOTION.

ABOUT SINGLE AXIS ACTUATOR

1-8 KP Product Series

K33 (Light-Load Type)

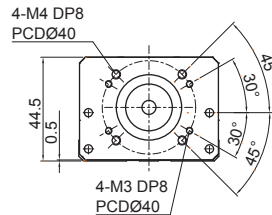
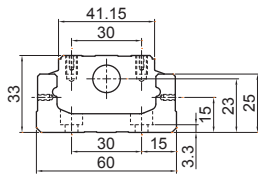
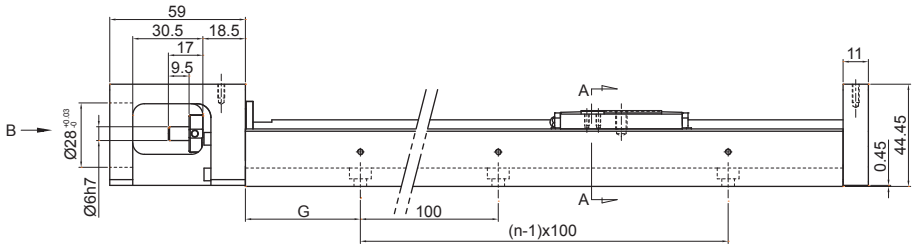
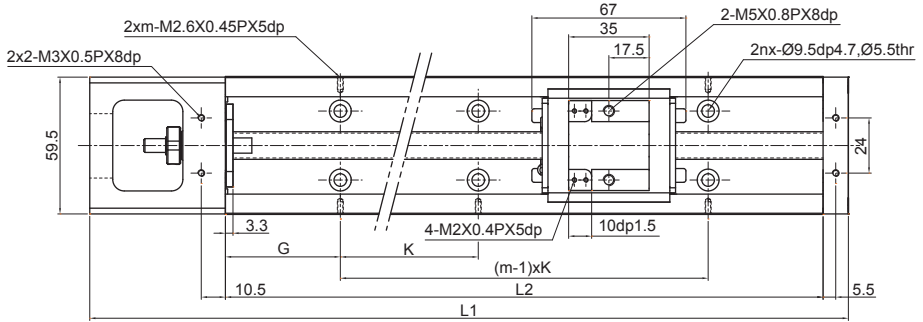

SECTION A-A

View B

Track length L2(mm)	Overall length L1(mm)	Max.travel(mm)		G(mm)	K(mm)	n	m	Total weight(kg)	
		NS	ND					NS	ND
150	220	79.5	-	25	100	2	2	1.4	1.6
200	270	129.5	68.5	50	100	2	2	1.7	1.9
300	370	229.5	168.5	50	200	3	2	2.3	2.5
400	470	329.5	268.5	50	100	4	4	2.9	3.1
500	570	429.5	368.5	50	200	5	3	3.5	3.7
600	670	529.5	468.5	50	100	6	6	4.1	4.3

※ NS slide base : with one slide base, ND slide base : with two slide bases.

※ Additional collar for motor side shaft end is available, if it is required please contact TBI MOTION.

KP33 (Light-Load Type with Protective Cap)

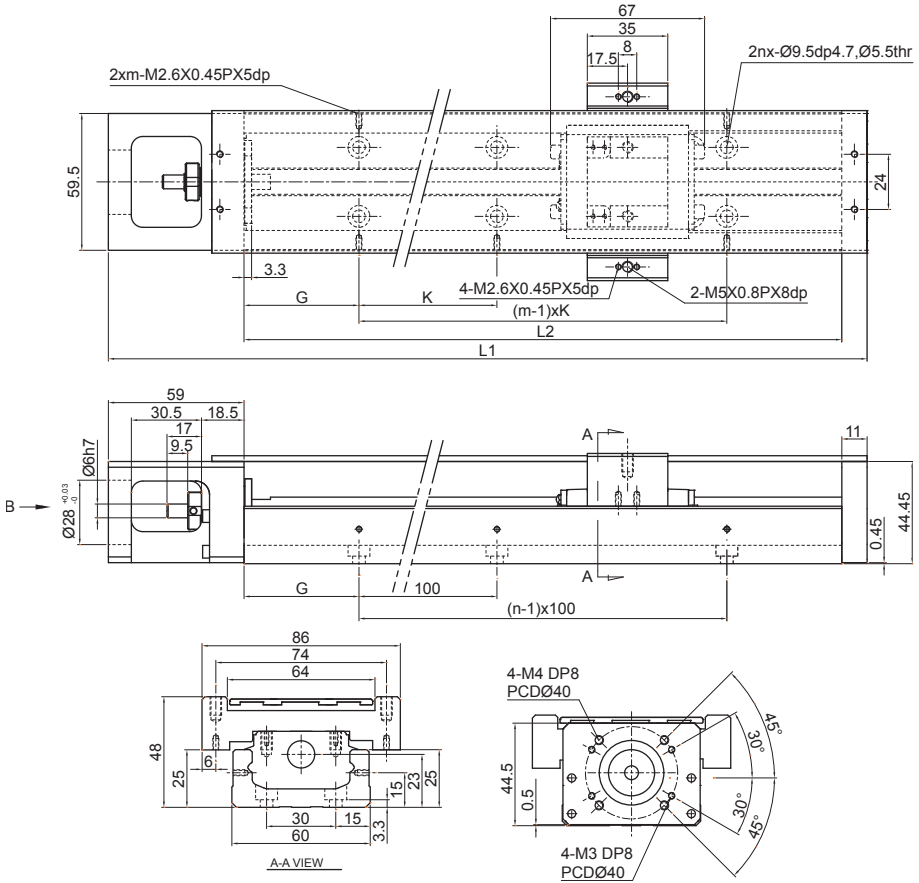

SECTION A-A

View B

Track length L2 (mm)	Overall length L1 (mm)	Max. travel (mm)		G(mm)	K(mm)	n	m	Total weight (kg)	
		NS	ND					NS	ND
150	220	79.5	-	25	100	2	2	1.4	1.6
200	270	129.5	68.5	50	100	2	2	1.7	1.9
300	370	229.5	168.5	50	200	3	2	2.3	2.5
400	470	329.5	268.5	50	100	4	4	2.9	3.1
500	570	429.5	368.5	50	200	5	3	3.5	3.7
600	670	529.5	468.5	50	100	6	6	4.1	4.3

※ NS slide base : with one slide base, ND slide base : with two slide bases.

※ Additional collar for motor side shaft end is available, if it is required please contact TBI MOTION.

ABOUT SINGLE AXIS ACTUATOR

1-8 KP Product Series

KP33 (Light-Load Type, Low-Assembly)

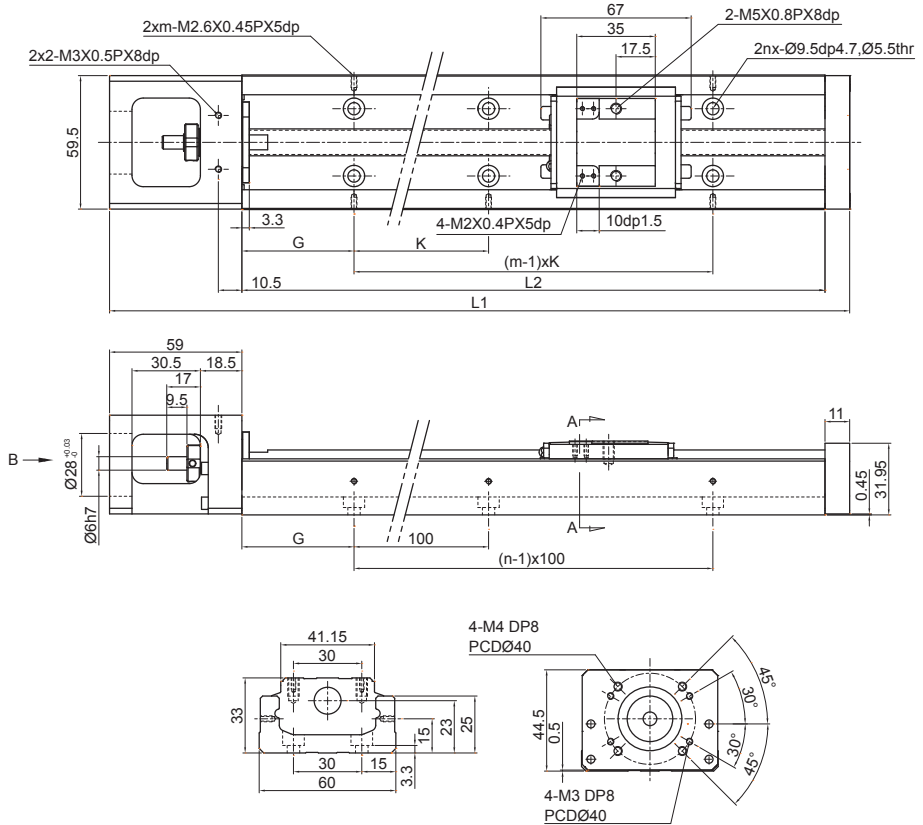

SECTION A-A

View B

Track length L2 (mm)	Overall length L1 (mm)	Max. travel (mm)		G(mm)	K(mm)	n	m	Total weight (kg)	
		NS	ND					NS	ND
150	220	79.5	-	25	100	2	2	1.4	1.6
200	270	129.5	68.5	50	100	2	2	1.7	1.9
300	370	229.5	168.5	50	200	3	2	2.3	2.5
400	470	329.5	268.5	50	100	4	4	2.9	3.1
500	570	429.5	368.5	50	200	5	3	3.5	3.7
600	670	529.5	468.5	50	100	6	6	4.1	4.3

※ NS slide base : with one slide base, ND slide base : with two slide bases.

※ Additional collar for motor side shaft end is available, if it is required please contact TBI MOTION.

KP46 (Standard Type)

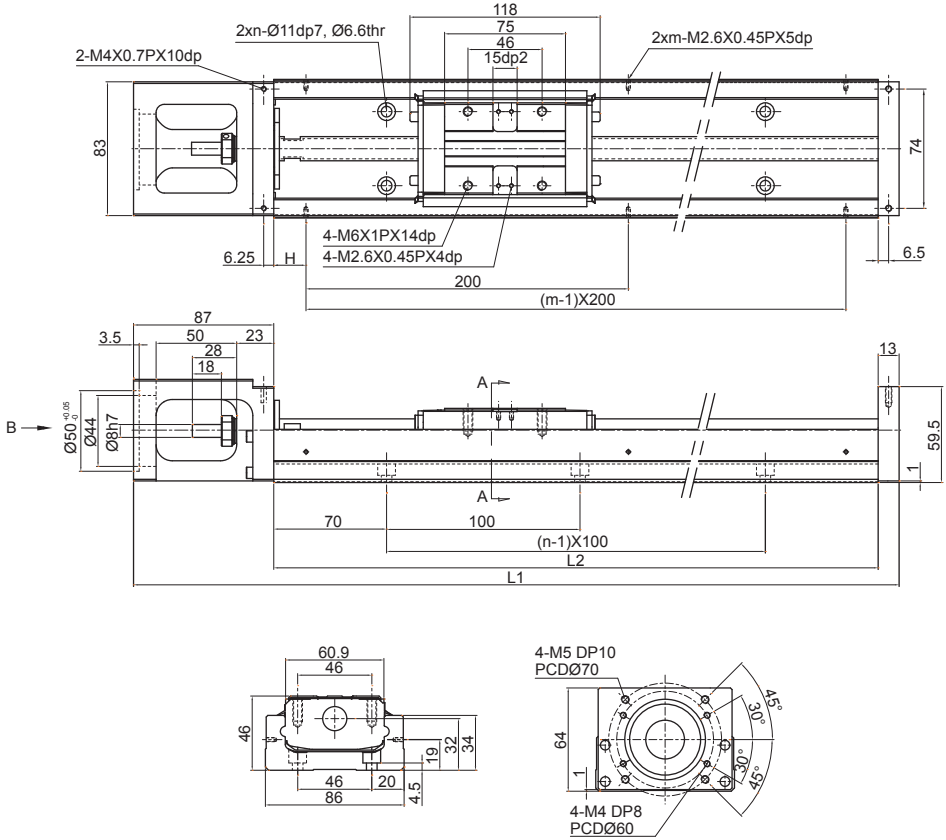

Single Axis Actuator

SECTION A-A

View B

Track length L2 (mm)	Overall length L1 (mm)	Max. travel (mm)		H(mm)	n	m	Total weight (kg)	
		LS	LD				LS	LD
340	440	218.5	106.5	70	3	2	5.7	6.5
440	540	318.5	206.5	20	4	3	6.9	7.7
540	640	418.5	306.5	70	5	3	8	8.8
640	740	518.5	406.5	20	6	4	9.2	10.1
740	840	618.5	506.5	70	7	4	10.4	11.3
940	1040	818.5	706.5	70	9	5	11.6	12.5

※ LS slide base : with one slide base, LD slide base : with two slide bases.
 ※ Additional collar for motor side shaft end is available, if it is required please contact TBI MOTION.

ABOUT SINGLE AXIS ACTUATOR

1-8 KP Product Series

KP46 (Standard Type with Protective Cap)

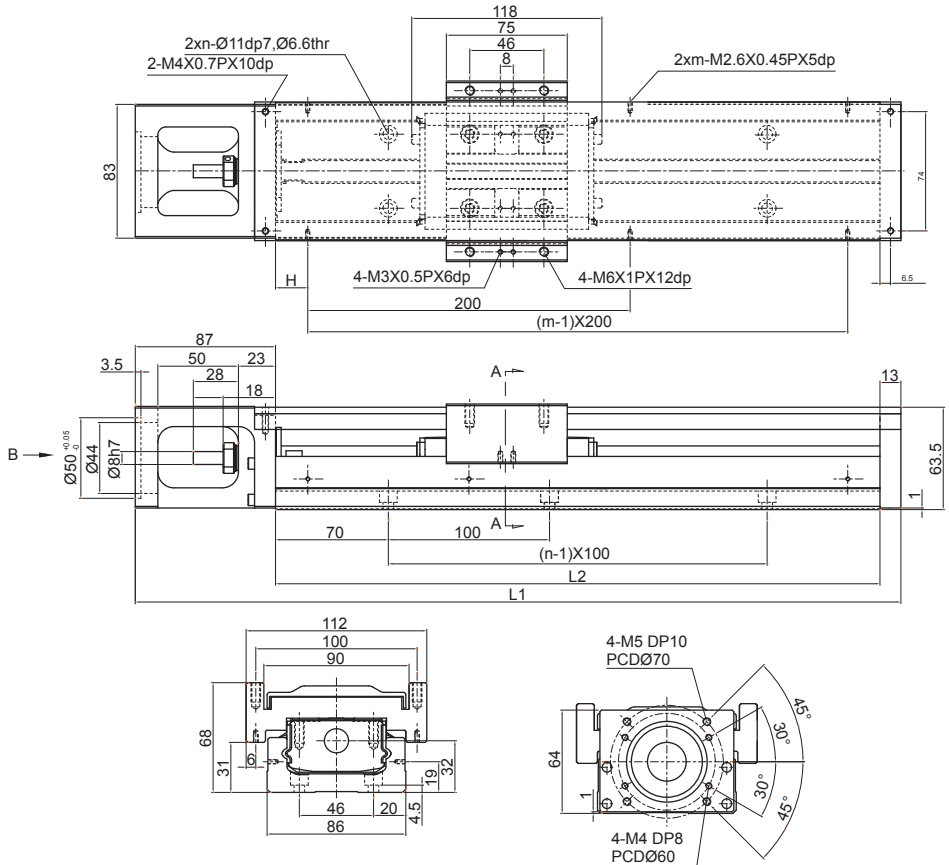

SECTION A-A

View B

Track length L2 (mm)	Overall length L1 (mm)	Max. travel (mm)		H(mm)	n	m	Total weight (kg)	
		LS	LD				LS	LD
340	440	218.5	106.5	70	3	2	6.5	7.3
440	540	318.5	206.5	20	4	3	7.8	8.6
540	640	418.5	306.5	70	5	3	9.0	9.8
640	740	518.5	406.5	20	6	4	10.3	11.3
740	840	618.5	506.5	70	7	4	11.6	12.4
940	1040	818.5	706.5	70	9	5	13.0	13.8

※LS slide base : with one slide base, LD slide base : with two slide bases.

※Additional collar for motor side shaft end is available, if it is required please contact TBI MOTION.

KP46 (Low-Assembly)

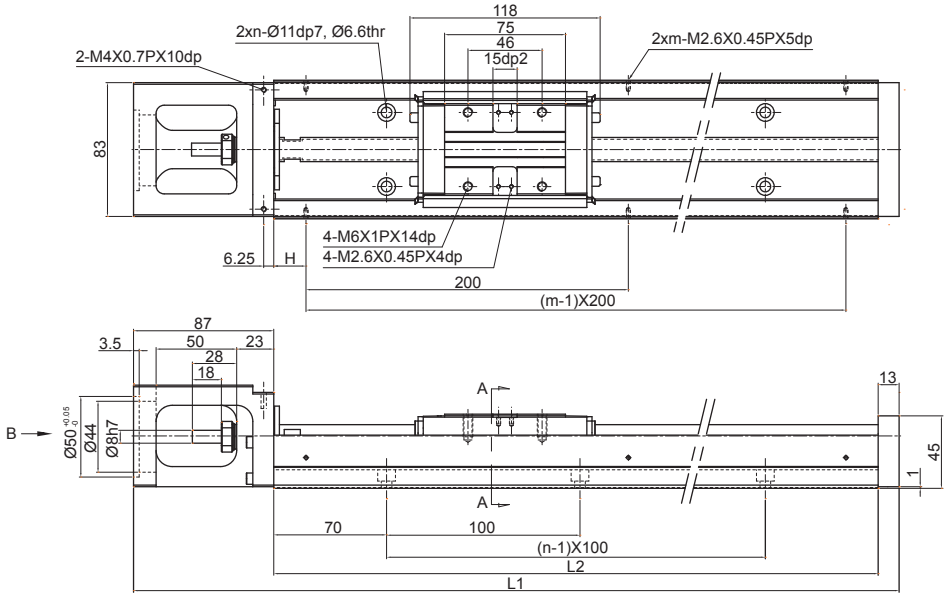

SECTION A-A

View B

Track length L2 (mm)	Overall length L1 (mm)	Max. travel (mm)		H(mm)	n	m	Total weight (kg)	
		LS	LD				LS	LD
340	440	218.5	106.5	70	3	2	6.5	7.3
440	540	318.5	206.5	20	4	3	7.8	8.6
540	640	418.5	306.5	70	5	3	9.0	9.8
640	740	518.5	406.5	20	6	4	10.3	11.3
740	840	618.5	506.5	70	7	4	11.6	12.4
940	1040	818.5	706.5	70	9	5	13.0	13.8

※LS slide base : with one slide base, LD slide base : with two slide bases.
 ※Additional collar for motor side shaft end is available, if it is required please contact TBI MOTION.

ABOUT SINGLE AXIS ACTUATOR

1-8 KP Product Series

K46 (Light-Load Type)

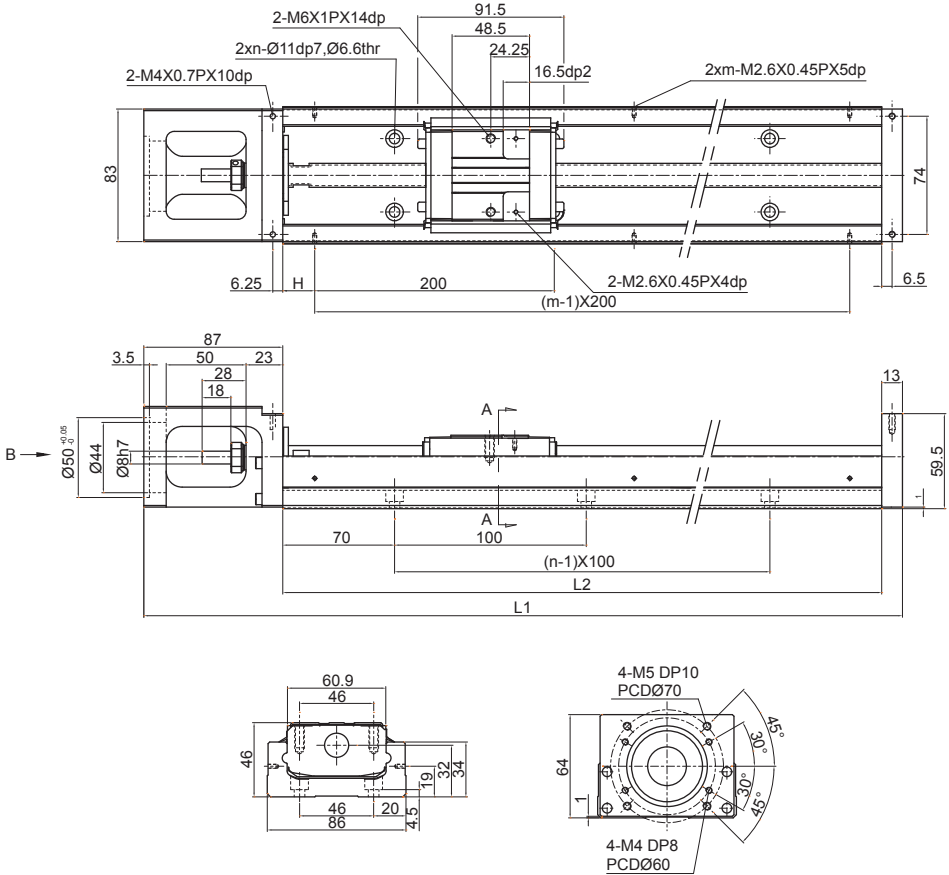

SECTION A-A

View B

Track length L2 (mm)	Overall length L1 (mm)	Max. travel (mm)		H(mm)	n	m	Total weight (kg)	
		NS	ND				NS	ND
340	440	245	159.5	70	3	2	5.4	5.9
440	540	345	259.5	20	4	3	6.6	7.1
540	640	445	359.5	70	5	3	7.7	8.2
640	740	545	459.5	20	6	4	8.9	9.4
740	840	645	559.5	70	7	4	10.1	10.6
940	1040	845	759.5	70	9	5	11.3	11.8

※ NS slide base : with one slide base, ND slide base : with two slide bases.

※ Additional collar for motor side shaft end is available, if it is required please contact TBI MOTION.

KP46 (Light-Load Type with Protective Cap)

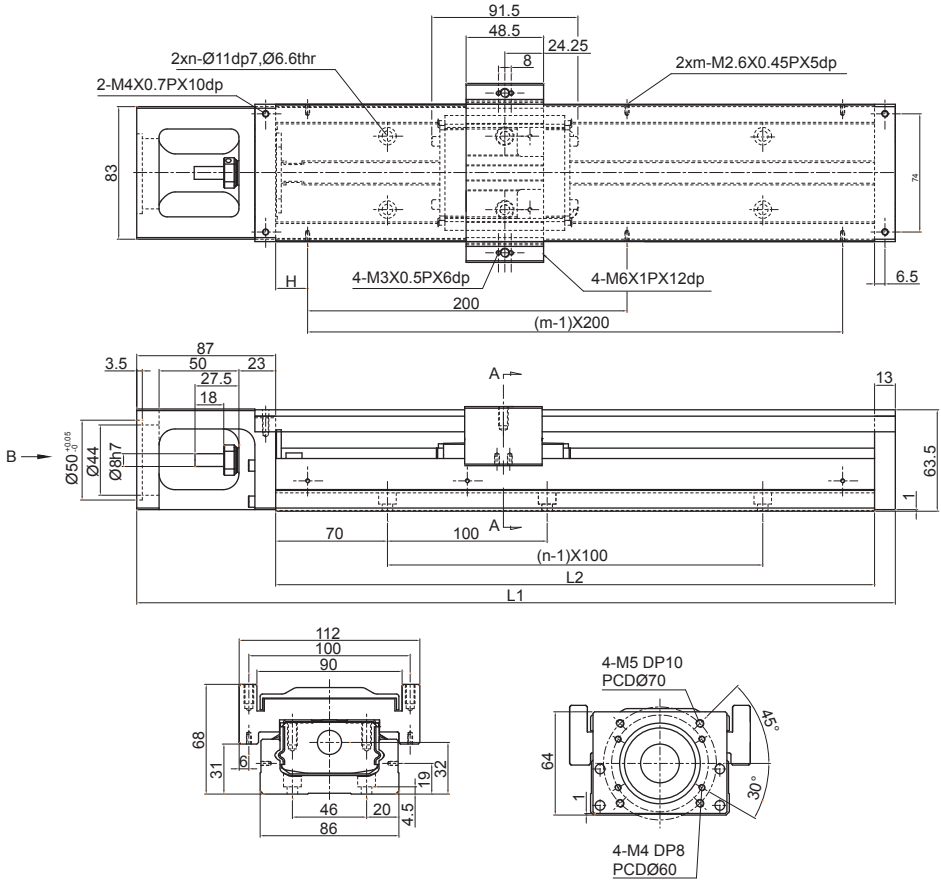

SECTION A-A

View B

Track length L2 (mm)	Overall length L1 (mm)	Max. travel (mm)		H(mm)	n	m	Total weight (kg)	
		NS	ND				NS	ND
340	440	245	159.5	70	3	2	6.3	7.1
440	540	345	259.5	20	4	3	7.6	8.4
540	640	445	359.5	70	5	3	8.8	9.6
640	740	545	459.5	20	6	4	10.1	11.1
740	840	645	559.5	70	7	4	11.4	12.2
940	1040	845	759.5	70	9	5	12.8	13.6

※ NS slide base : with one slide base, ND slide base : with two slide bases.
 ※ Additional collar for motor side shaft end is available, if it is required please contact TBI MOTION.

ABOUT SINGLE AXIS ACTUATOR

1-8 KP Product Series

KP46 (Light-Load Type, Low-Assembly)

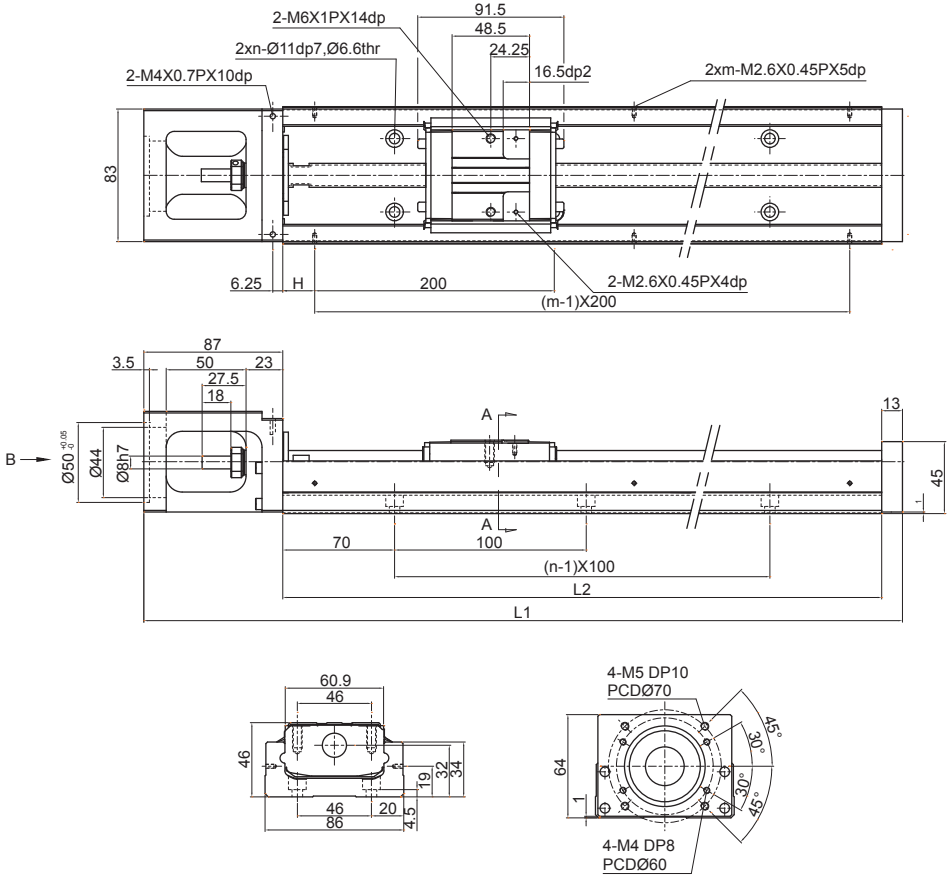

SECTION A-A

View B

Track length L2 (mm)	Overall length L1 (mm)	Max. travel (mm)		H(mm)	n	m	Total weight (kg)	
		NS	ND				NS	ND
340	440	245	159.5	70	3	2	6.3	7.1
440	540	345	259.5	20	4	3	7.6	8.4
540	640	445	359.5	70	5	3	8.8	9.6
640	740	545	459.5	20	6	4	10.1	11.1
740	840	645	559.5	70	7	4	11.4	12.2
940	1040	845	759.5	70	9	5	12.8	13.6











※ NS slide base : with one slide base, ND slide base : with two slide bases.

※ Additional collar for motor side shaft end is available, if it is required please contact TBI MOTION.

1-9 The Adapting Flange of the Motor Base and the Motor

1-9-1 List of Suitable Motors









Table 1.9.1 Mitsubishi Servo Motors

NO.	Power Output	Motor	weight (kg)	Suitable Flange			Brake (kg)	Drive	weight (kg)	Remarks
				KP26	KP33	KP46				
M01	50W	HG-KR053	0.34	F01	F05	F12	-	MR-J4-10A	0.8	220V 
M02	50W	HG-KR053K	0.34	F01	F05	F12	-	MR-J4-10A	0.8	220V 
M03	100W	HG-KR13	0.54	F01	F05	F12	-	MR-J4-10A	0.8	220V 
M04	100W	HG-KR13K	0.54	F01	F05	F12	-	MR-J4-10A	0.8	220V 
M05	200W	HG-KR23	0.91	-	-	F10	-	MR-J4-20A	0.8	220V 
M06	200W	HG-KR23K	0.91	-	-	F10	-	MR-J4-20A	0.8	220V 
M07	400W	HG-KR43	1.4	-	-	F10	-	MR-J4-40A	1	220V 
M08	400W	HG-KR43K	1.4	-	-	F10	-	MR-J4-40A	1	220V 
M09	750W	HG-KR73	2.8	-	-	-	-	MR-J4-70A	1.4	220V 
M10	750W	HG-KR73K	2.8	-	-	-	-	MR-J4-70A	1.4	220V 

(1) A Single Axis Actuator includes a servo motor with supply wire, detector connecting wire and servo connector, supply wire and detector connecting wire are 3 meters long. 3m supply wire(3m, MIT) MR-PW51CBL3M-A2-L-T/ 3m detector connecting wire(3m, MIT)MR-J3ENCBL3M-A2-L-T, servo connector SMR-J3CN1.







(2) Exclude the battery of absolute position detecting system.

Table 1.9.2 Panasonic Servo Motors

NO.	Power Output	Motor	weight (kg)	Suitable Flange			Brake (kg)	Drive	weight (kg)	Remarks
				KP26	KP33	KP46				
M11	50W	MSMF5AZL1U2	0.32	F02	F06	F13	0.53	MADLN01SE	0.8	210V 
M12	50W	MSMF5AZL1U2	0.32	F02	F06	F13	0.53	MADLN05SE	0.8	220V 
M13	100W	MSMF011L1U2	0.47	F02	F06	F13	0.68	MADLN11SE	0.8	210V 
M14	100W	MSMF012L1U2	0.47	F02	F06	F13	0.68	MADLN05SE	0.8	220V 
M15	200W	MSMF021L1U2	0.82	-	-	F11	1.3	MBDLN21SE	1	210V 
M16	200W	MSMF022L1U2	0.82	-	-	F11	1.3	MADLN15SE	0.8	220V 
M17	400W	MSMF041L1U2	1.2	-	-	F11	1.7	MCDLN31SE	1.6	210V 
M18	400W	MSMF042L1U2	1.2	-	-	F11	1.7	MBDLN25SE	1	220V 
M19	750W	MSMF082L1U2	2.3	-	-	-	3.1	MCDLN35SE	1.6	220V 

(1) A single axis actuator includes a servo motor with supply wire, coding wire, I/F adaptor, supply wire and coding wire are 1m, 3m or 5m long, without designation wires would be 3 meters long.





















(2) Exclude the battery of absolute position detecting system.

Incremental type	Pulse type	D-Axis	Low-inertia	Medium-inertia	Low-capacity	No Grease Seal	Grease Seal	With Brake	No Brake	Key Way	Key Way, Threaded Hole	Optical Axis
												

ABOUT SINGLE AXIS ACTUATOR

1-9 The Adapting Flange of the Motor Base and the Motor

Table 1.9.3 Yaskawa Servo Motors

NO.	Power Output	Motor	weight (kg)	Suitable Flange			Brake (kg)	Drive	weight (kg)	Remarks
				KP26	KP33	KP46				
M20	50W	SGM7J-A5AF61	0.3	F01	F05	F12	-	SGD7S-R70A00A	0.8	220V 
M21	50W	SGM7J-A5AF6C	0.6	F01	F05	F12	0.6	SGD7S-R70A00A	0.8	220V 
M22	50W	SGM7J-A5AF6S	0.3	F01	F05	F12	-	SGD7S-R70A00A	0.8	220V 
M23	50W	SGM7J-A5AF6E	0.6	F01	F05	F12	0.6	SGD7S-R70A00A	0.8	220V 
M24	100W	SGM7J-01AF61	0.4	F01	F05	F12	-	SGD7S-R90A00A	0.8	220V 
M25	100W	SGM7J-01AF6C	0.7	F01	F05	F12	0.7	SGD7S-R90A00A	0.8	220V 
M26	100W	SGM7J-01AF6S	0.4	F01	F05	F12	-	SGD7S-R90A00A	0.8	220V 
M27	100W	SGM7J-01AF6E	0.7	F01	F05	F12	0.7	SGD7S-R90A00A	0.8	220V 
M28	200W	SGM7J-02AF61	0.8	-	-	F10	-	SGD7S-1R6A00A	0.8	220V 
M29	200W	SGM7J-02AF6C	1.4	-	-	F10	1.4	SGD7S-1R6A00A	0.8	220V 
M30	200W	SGM7J-02AF6S	0.8	-	-	F10	-	SGD7S-1R6A00A	0.8	220V 
M31	200W	SGM7J-02AF6E	1.4	-	-	F10	1.4	SGD7S-1R6A00A	0.8	220V 
M32	400W	SGM7J-04AF61	1.1	-	-	F10	-	SGD7S-2R8A00A	1	220V 
M33	400W	SGM7J-04AF6C	1.7	-	-	F10	1.7	SGD7S-2R8A00A	1	220V 
M34	400W	SGM7J-04AF6S	1.1	-	-	F10	-	SGD7S-2R8A00A	1	220V 
M35	400W	SGM7J-04AF6E	1.7	-	-	F10	1.7	SGD7S-2R8A00A	1	220V 
M36	750W	SGM7J-08AF61	2.2	-	-	-	-	SGD7S-5R5A00A	1.6	220V 
M37	750W	SGM7J-08AF6C	2.8	-	-	-	2.8	SGD7S-5R5A00A	1.6	220V 
M38	750W	SGM7J-08AF6S	2.2	-	-	-	-	SGD7S-5R5A00A	1.6	220V 
M39	750W	SGM7J-08AF6E	2.8	-	-	-	2.8	SGD7S-5R5A00A	1.6	220V 

(1) A single axis actuator includes a servo motor with supply wire, coding wire and servo connector, supply wire and coding wire are 3 meters long.

3m supply wire(No actuator) JZSP-C7M10F-03-E(50W), JZSP-C7M20F-03-E(100W, 200W, 400W), JZSP-C7M30F-03-E(750W)

3m supply wire(with actuator) JZSP-C7M13F-03-E(50W), JZSP-C7M23F-03-E(100W, 200W, 400W), JZSP-C7M33-03-E-(750W)

coding wire JZSP-C7P10D-03-E CN1 adaptor 3M-MDR(50P)













Incremental type	Pulse type	D-Axis	Low-inertia	Medium-inertia	Low-capacity	No Grease Seal	Grease Seal	With Brake	No Brake	Key Way	Key Way, Threaded Hole	Optical Axis
												

Table 1.9.4 Oriental Step Motors

















NO.	Series	Specification	Suitable Flange			Motor	weight (kg)	Drive	weight (kg)	Remarks
			KP26	KP33	KP46					
M40	RK II	RKS543AA-3	F03	F09	-	PKE543AC	0.26	RKSD503-A	0.8	110V
M41		RKS544AA-3	F03	F09	-	PKE544AC	0.32	RKSD503-A	0.8	
M42		RKS545AA-3	F03	F09	-	PKE545AC	0.38	RKSD503-A	0.8	
M43		RKS566AA-3	-	-	F15	PKE566AC	0.9	RKSD507-A	0.8	
M44		RKS569AA-3	-	-	F15	PKE569AC	1.4	RKSD507-A	0.8	
M45		RKS596AA-3	-	-	-	PKE596AC	1.9	RKSD507-A	0.8	
M46		RKS599AA-3	-	-	-	PKE599AC	3	RKSD507-A	0.8	
M47		RKS5913AA-3	-	-	-	PKE5913AC	4.1	RKSD507-A	0.8	

※Include 3 meters long supply wire for servo motor.

ABOUT SINGLE AXIS ACTUATOR

1-9 The Adapting Flange of the Motor Base and the Motor

Table 1.9.5 Shihlin Motors













NO.	Power Output	Motor	weight (kg)	Suitable Flange			Brake (kg)	Drive	weight (kg)	Remarks
				KP26	KP33	KP46				
M48	100W	SME-L01030SAA	0.45	F01	F05	F12	-	SDE-010A2	1.4	220V 
M49	100W	SME-L01030SAB	0.45	F01	F05	F12	-	SDE-010A2	1.4	220V 
M50	100W	SME-L01030SBA	0.67	F01	F05	F12	0.67	SDE-010A2	1.4	220V 
M51	100W	SME-L01030SBB	0.67	F01	F05	F12	0.67	SDE-010A2	1.4	220V 
M52	200W	SME-L02030SAA	0.85	-	-	F10	-	SDE-020A2	1.4	220V 
M53	200W	SME-L02030SAB	0.85	-	-	F10	-	SDE-020A2	1.4	220V 
M54	200W	SME-L02030SBA	1.23	-	-	F10	1.23	SDE-020A2	1.4	220V 
M55	200W	SME-L02030SBB	1.23	-	-	F10	1.23	SDE-020A2	1.4	220V 
M56	400W	SME-L04030SAA	1.23	-	-	F10	-	SDE-040A2	1.4	220V 
M57	400W	SME-L04030SAB	1.23	-	-	F10	-	SDE-040A2	1.4	220V 
M58	400W	SME-L04030SBA	1.59	-	-	F10	1.59	SDE-040A2	1.4	220V 
M59	400W	SME-L04030SBB	1.59	-	-	F10	1.59	SDE-040A2	1.4	220V 
M60	750W	SME-L07530SAA	2.24	-	-	-	-	SDE-075A2	1.7	220V 
M61	750W	SME-L07530SAB	2.24	-	-	-	-	SDE-075A2	1.7	220V 
M62	750W	SME-L07530SBA	2.87	-	-	-	2.87	SDE-075A2	1.7	220V 
M63	750W	SME-L07530SBB	2.87	-	-	-	2.87	SDE-075A2	1.7	220V 

※(1) A single axis actuator includes a servo motor with supply wire, coding wire, I/F adaptor, supply wire and coding wire are mainly 3 meters long.

Supply wire SDA-PWCNL1-3M-L

Supply wire(for brake) SDA-PWCNL2-3M-L

Coding wire SDH-ENL-3M-L

Incremental type	Pulse type	D-Axis	Low-inertia	Medium-inertia	Low-capacity	No Grease Seal	Grease Seal	With Brake	No Brake	Key Way	Key Way, Threaded Hole	Optical Axis
												

1-9-2 The Adapting Flange of the Motor Base and the Motor

KP26

Motor Base F00

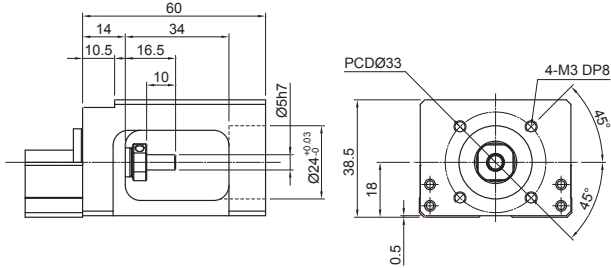

Motor Adapting Flange F01

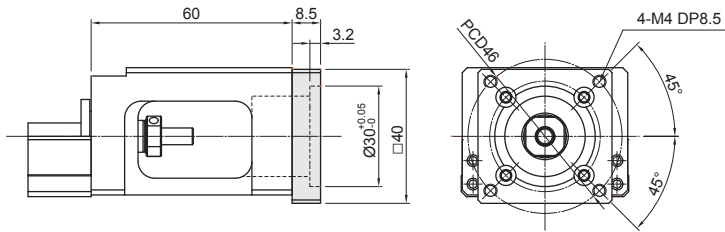

Motor Adapting Flange F02

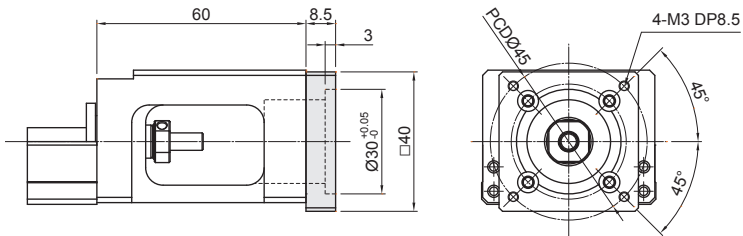

Motor Adapting Flange F03

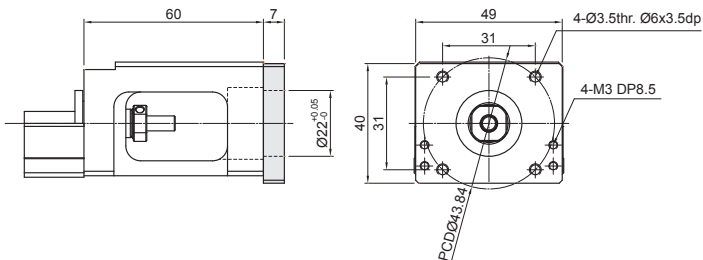

ABOUT SINGLE AXIS ACTUATOR

1-9 The Adapting Flange of the Motor Base and the Motor

KP33

Motor Base F04

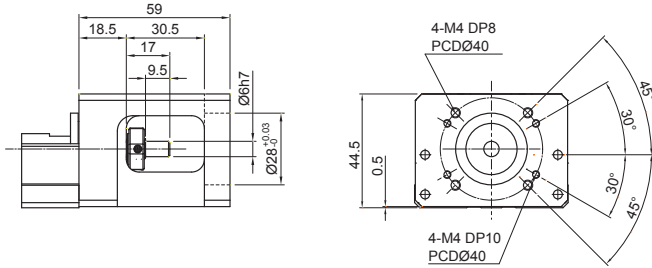

Motor Adapting Flange F05

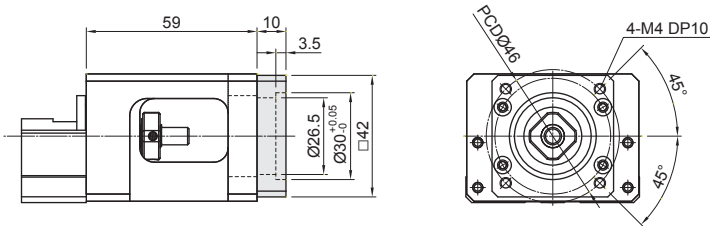

Motor Adapting Flange F06

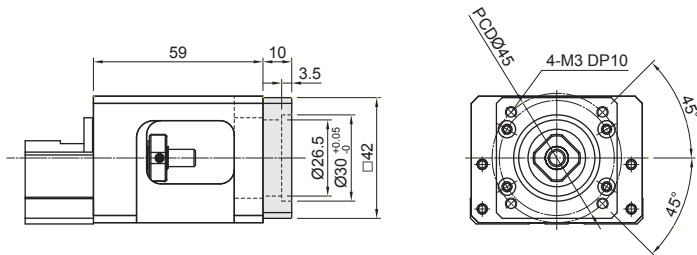

Motor Adapting Flange F07

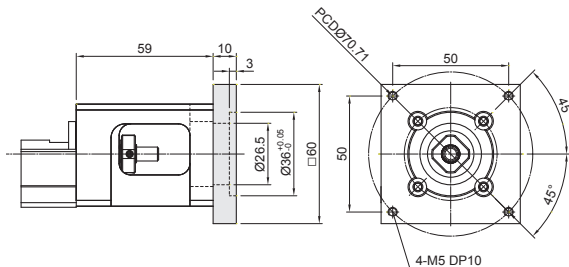

Single Axis Actuator

KP33

Motor Adapting Flange F08

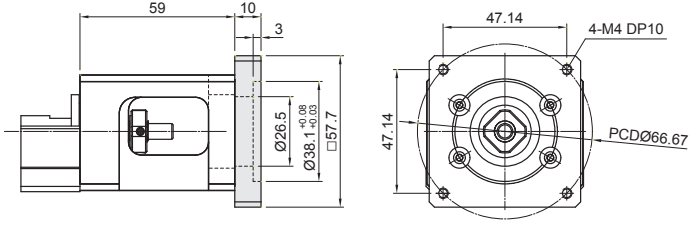

Motor Adapting Flange F09

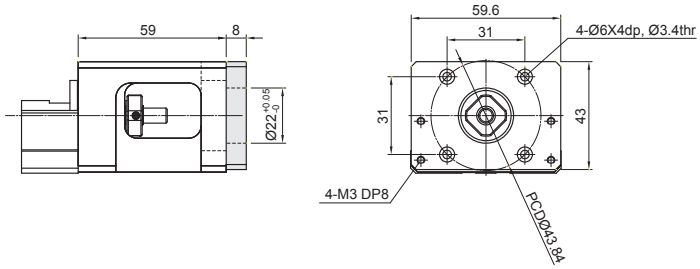

ABOUT SINGLE AXIS ACTUATOR

1-9 The Adapting Flange of the Motor Base and the Motor

KP46

Motor Base F10

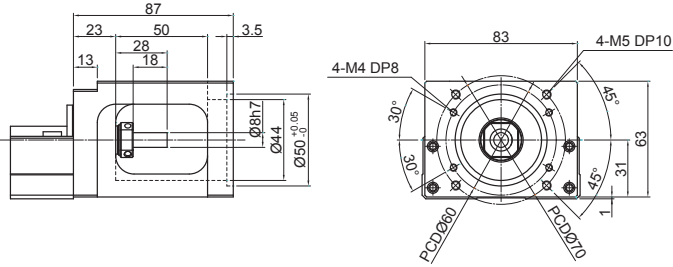

Motor Adapting Flange F11

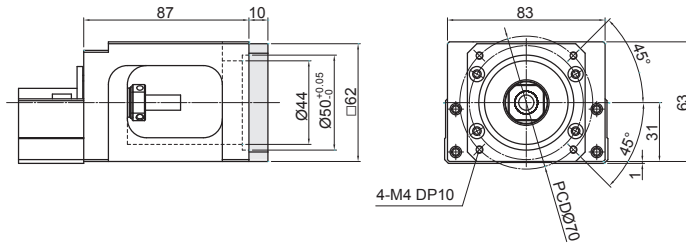

Motor Adapting Flange F12

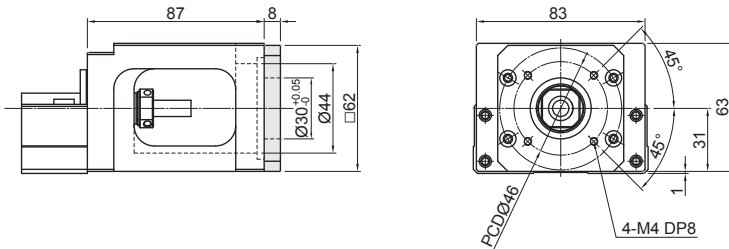

Motor Adapting Flange F13

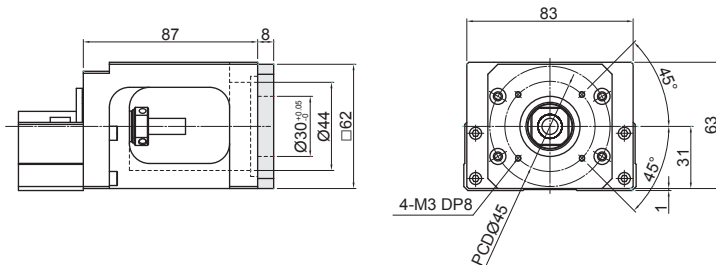

Single Axis Actuator

KP46

Motor Adapting Flange F14

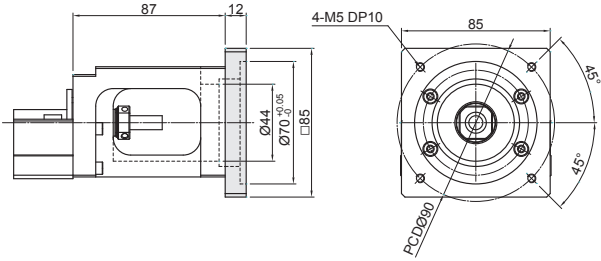

Motor Adapting Flange F15

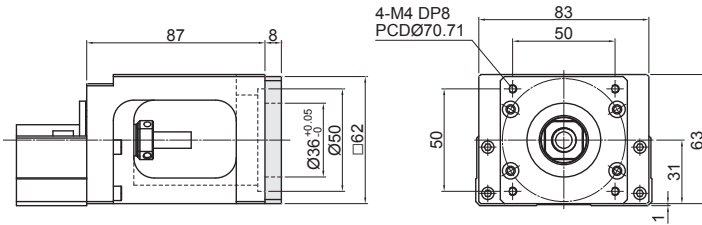

Motor Adapting Flange F16

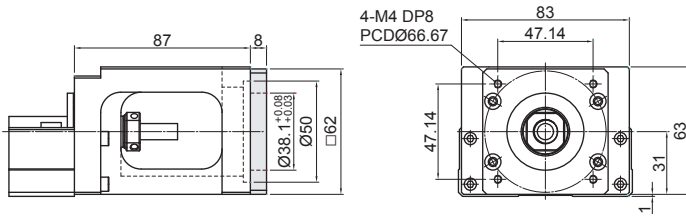

ABOUT SINGLE AXIS ACTUATOR

1-9 The Adapting Flange of the Motor Base and the Motor

■ 1-9-3 Sensor

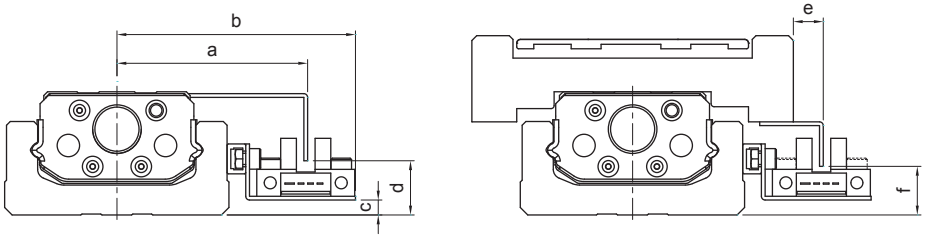

NO.	Nominal Model	a	b	c	d	e	f
S04	KP26	45.5	59	1	10	15	11
S05	KP33	51	63.8	4	14.5	8	13
S06	KP46	63.5	76.7	8	18	8	18

Sensor 1 : Omron EE-SX671.

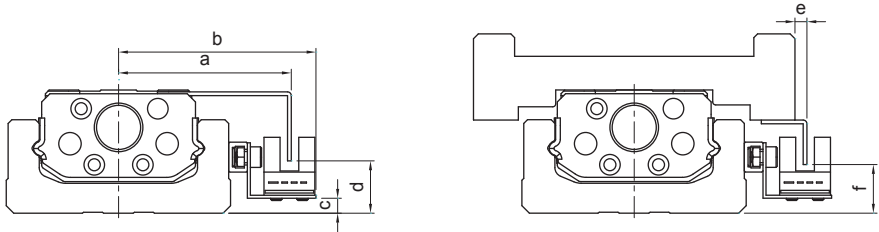

NO.	Nominal Model	a	b	c	d	e	f
S07	KP26	41.3	48	1	10.5	10.2	11
S08	KP33	46.2	52.8	4	14	3.2	13
S09	KP46	59	65.7	8	18	3	18

Sensor 2 : Omron EE-SX674.



Single Axis Actuator

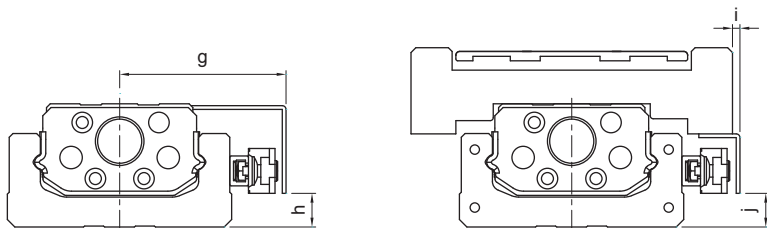

NO.	Nominal Model	g	h	i	j
S10	KP26	39.5	5.7	7	19.5
S11	KP33	44.5	9	2	9
S12	KP46	57	13	1	13

Sensor 3 : SUNX GX-F12A.

NO.	Nominal Model	g	h	i	j
S13	KP26	39.5	5.7	7	19.5
S14	KP33	44.5	9	2	9
S15	KP46	57	13	1	13

Sensor 4 : SUNX GX-F12A-P.

■ 1-9-4 Sensor Track

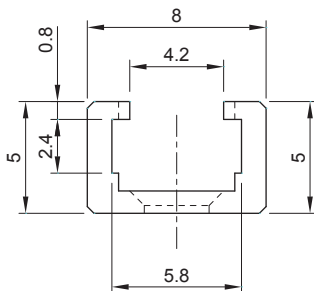

Table 1.9.6 List of Suitable Tracks

NO.	Nominal Model
S01	KP26
S02	KP33
S03	KP46