

I117CIN



INOX

MUSHROOM KNOB WITH FEMALE THREADED INSERT

Material:
Reinforced polyamide.
Oils and greases resistant.

Surface:
Satin.

Colour:
Black (RAL 9011).

Main Insert:
Stainless steel blind threaded bush.
(AISI 303) (tolerance 6H).

SPECIAL REQUEST:

- It is possible to supply colours as shown in the table at pag. I-25, on request and for quantities.

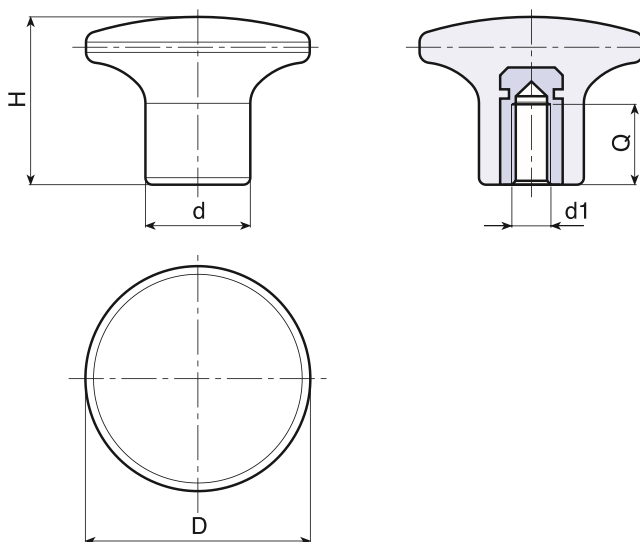

	art.	D	H	d	d1	Q	g
●	I11722.TM0501CIN	22	17	11	M05	9	8
●	I11722.TM0601CIN	22	17	11	M06	9	9
●	I11726.TM0501CIN	26	20,5	13	M05	9	10
●	I11726.TM0601CIN	26	20,5	13	M06	9	11
●	I11726.TM0801CIN	26	20,5	13	M08	13	12
●	I11732.TM0601CIN	32	24	15	M06	14	16
●	I11732.TM0801CIN	32	24	15	M08	13	18
●	I11745.TM1001CIN	45	32	21	M10	16	35
●	I11745.TM1201CIN	45	32	21	M12	15	39