

SFWR TÍPUS SFWR TYPE

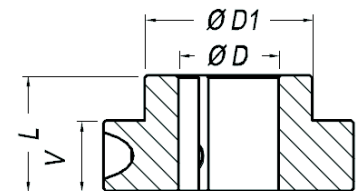
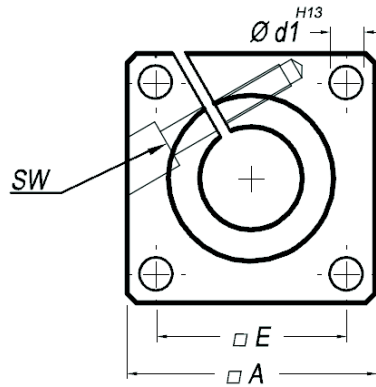
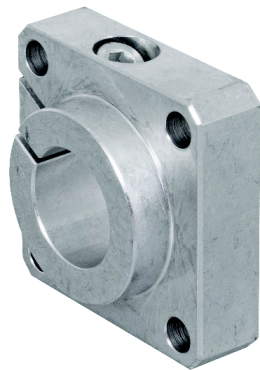

Cikkszám Code	Típus Type	D	A	L	D1	E	d1	V	SW	Tömeg Weight
		(mm)								
84.007.005	SFWR-12	12	40	20	23,5	30	5,5	12	M3	50
84.007.007	SFWR-16	16	50	20	27,5	35	5,5	12	M3	80
84.007.009	SFWR-20	20	50	23	33,5	38	6,6	14	M4	100
84.007.011	SFWR-25	25	60	25	42	42	6,6	16	M5	150
84.007.013	SFWR-30	30	70	30	49,5	54	9	19	M6	240
84.007.015	SFWR-40	40	100	40	65	68	11	26	M8	660
84.007.016	SFWR-50	50	100	50	75	75	11	36	M8	820

Anyaga: alumínium
Material: aluminium