

FGWN TÍPUS
FGWN TYPE

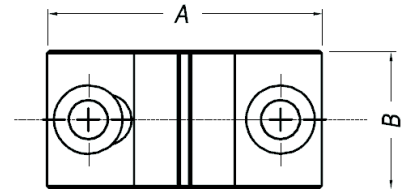
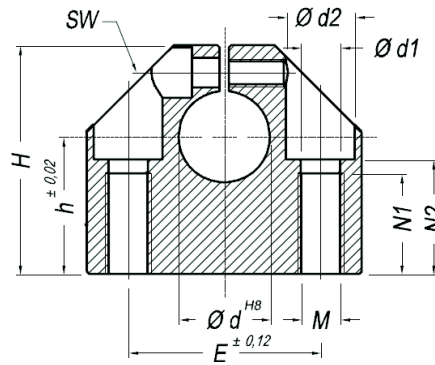

Cikkszám Code	Típus Type	d	A	B	H	h	E	d1	d2	M	N1	N2	SW	Tömeg Weight
		(mm)												(g)
84.008.003	FGWN-8	8	32	18	28	15	22	3,3	6	M4	9	13	M3	30
84.008.005	FGWN-12	12	43	20	35	20	30	5,2	10	M6	13	16,5	M3	60
84.008.007	FGWN-16	16	53	24	42	25	38	6,8	11	M8	18	21	M4	110
84.008.009	FGWN-20	20	60	30	50	30	42	8,6	15	M10	22	25	M5	170
84.008.011	FGWN-25	25	78	38	61	35	56	10,3	18	M12	26	30	M6	360
84.008.013	FGWN-30	30	87	40	70	40	64	10,3	18	M12	26	34	M6	460
84.008.015	FGWN-40	40	108	48	90	50	82	14,25	20	M16	34	44	M8	860
84.008.016	FGWN-50	50	132	58	105	60	100	17,5	26	M20	43	49	M10	1450

Anyaga: alumínium
Material: aluminium